

PowerScan™ 9500 Family

Industrial Corded Handheld
Area Imager Bar Code Reader

PowerScan PD9530/PBT9500/PM9500



Product Reference Guide

Datalogic ADC, Inc.

959 Terry Street | Eugene | OR 97402 | USA

Telephone: (1) 541-683-5700 | Fax: (1) 541-345-7140

©2013 Datalogic, Inc.

An Unpublished Work - All rights reserved. No part of the contents of this documentation or the procedures described therein may be reproduced or transmitted in any form or by any means without prior written permission of Datalogic ADC, Inc. or its subsidiaries or affiliates ("Datalogic" or 'Datalogic ADC"). Owners of Datalogic products are hereby granted a non-exclusive, revocable license to reproduce and transmit this documentation for the purchaser's own internal business purposes. Purchaser shall not remove or alter any proprietary notices, including copyright notices, contained in this documentation and shall ensure that all notices appear on any reproductions of the documentation.

Should future revisions of this manual be published, you can acquire printed versions by contacting your Datalogic representative. Electronic versions may either be downloadable from the Datalogic website (www.datalogic.com) or provided on appropriate media. If you visit our website and would like to make comments or suggestions about this or other Datalogic publications, please let us know via the "Contact Datalogic" page.

Disclaimer

Datalogic has taken reasonable measures to provide information in this manual that is complete and accurate, however, Datalogic reserves the right to change any specification at any time without prior notice.

Datalogic and the Datalogic logo are registered trademarks of Datalogic S.p.A. in many countries, including the U.S.A. and the E.U. All other brand and product names may be trademarks of their respective owners.

Patents

This product may be covered by one or more of the following patents:

Design Patents: AU344427; AU344428; AU344429; EP1970237; USD682277;
ZL201230284676.X

Utility Patents: EP996284; EP999514; EP1128315; EP1172756; EP1396811; EP1413971;
EP1828957; JP4435343; US5481098; US6478224; US6512218; US6513714; US6561427;
US6808114; US6877664; US6997385; US7053954; US7234641; US7387246; US7721966.

Additional patents pending.



Table of Contents

- INTRODUCTION..... 1**
 - About this Manual 1**
 - Overview 1
 - Manual Conventions 2
 - References 2**
 - Technical Support 2**
 - Datalogic Website Support 2
 - Reseller Technical Support 2
 - Telephone Technical Support 2
 - About the Reader 3**
 - PM8500 Compatible Mode: 3
 - The BC9xx0™ Base Station/Charger 4**
 - Battery Safety 5**
 - Programming the Reader 6**
 - Configuration Methods 6
- SETUP 7**
 - Unpacking 7**
 - Setting Up the Reader 7**
 - Connecting the Cable (Corded versions) 8
 - Configuring the Base Station 9**
 - Mounting the BC9xx0 Cradle 9**
 - Mounting Brackets 9
 - Permanent Mounting 10
 - Mounting for Portable Use 11
 - System Connections 12
 - Connecting and Disconnecting the Interface Cable 13
 - BC9xx0 Configuration 14
 - Interface Selection 14**
 - Setting the Interface 14
 - Customizing Configuration Settings 17**
 - Configure Interface Settings 17
 - Global Interface Features 17
 - Configuring Other Features 17
 - Software Version Transmission 17
 - Self Test and Statistics 17
 - Resetting the Product Configuration to Defaults 18
 - Set Date and Time 18
 - Linking the Reader 19**
 - Link Datalogic RF Devices to Base 19
 - Linking to a Bluetooth Adapter in Serial Port Profile (Slave) Mode 19
 - Linking to a Bluetooth Adapter in HID mode 19
 - Power Off 20
- CONFIGURATION USING BAR CODES 21**
 - Configuration Parameters 21
 - GLOBAL INTERFACE FEATURES 23
 - Host Commands — Obey/Ignore 23
 - USB Suspend Mode 23
 - RS-232 Only Interface25**
 - Baud Rate 26
 - Data Bits 27
 - Stop Bits 27
 - Parity 28
 - Handshaking Control 29
 - RS-232/USB-Com Interfaces30**
 - Intercharacter Delay 31
 - Beep On ASCII BEL 31

Beep On Not on File	32
ACK NAK Options	32
ACK Character	33
NAK Character	33
ACK NAK Timeout Value	34
ACK NAK Retry Count	34
ACK NAK Error Handling	35
Indicate Transmission Failure	35
Disable Character	36
Enable Character	36
Keyboard Settings	37
Country Mode	38
Send Control Characters	41
Wedge Quiet Interval	42
Intercode Delay	42
Caps Lock State	43
Numlock	43
USB Keyboard Speed	44
USB Keyboard Numeric Keypad	45
USB-OEM Interface	47
USB-OEM Device Usage	48
Interface Options	48
Data Format	49
Global Prefix/Suffix (Header/Terminator)	50
Global AIM ID	51
Set AIM ID Individually for GS1-128	54
Label ID	55
Label ID: Pre-Loaded Sets	55
Individually Set Label ID	56
Label ID Control	56
Label ID Symbology Selection – 1D Symbologies	57
Advanced Formatting: User Label Edit	61
Case Conversion	61
Character Conversion	61
Reading Parameters	63
Double Read Timeout	64
LED AND BEEPER INDICATORS	66
Power On Alert	66
Good Read: When to Indicate	66
Good Read Beep Type	67
Good Read Beep Frequency	67
Good Read Beep Length	68
Good Read Beep Volume	69
Good Read LED Duration	70
SCANNING FEATURES	71
Scan Mode	71
Stand Mode Indication	72
Pick Mode	72
Stand Mode Sensitivity	73
Stand Mode Illumination Off Time	73
Scanning Active Time	74
Stand Illumination Control	74
Flash On Time	75
Flash Off Time	75
Aiming Pointer	76
Aiming Duration Timer	76
Green Spot Duration	77
Partial Label Reading Control	77
Decode Negative Image	78
Image Capture	78
MULTIPLE LABEL READING	79
Multiple Labels per Frame	79
Multiple Labels Ordering by Code Symbology	80
Multiple Labels Ordering by Code Length	80
1D Symbologies	81
DISABLE ALL SYMBOLOGIES	82

CODE EAN/UPC	83
Coupon Control	83
UPC-A	84
UPC-A Enable/Disable	84
UPC-A Check Character Transmission	84
Expand UPC-A to EAN-13	85
UPC-A Number System Character Transmission	85
UPC-A 2D Component	86
UPC-E	86
UPC-E Enable/Disable	86
UPC-E Check Character Transmission	87
UPC-E 2D Component	87
Expand UPC-E to EAN-13	88
Expand UPC-E to UPC-A	88
UPC-E Number System Character Transmission	89
GTIN FORMATTING	89
EAN 13 (JAN 13)	90
EAN 13 Enable/Disable	90
EAN 13 Check Character Transmission	90
EAN-13 Flag 1 Character	91
EAN-13 ISBN Conversion	91
EAN-13 2D Component	92
ISSN	92
ISSN Enable/Disable	92
EAN 8 (JAN 8)	93
EAN 8 Enable/Disable	93
EAN 8 Check Character Transmission	93
Expand EAN 8 to EAN 13	94
EAN 8 2D Component	94
UPC/EAN GLOBAL SETTINGS	95
UPC/EAN Price Weight Check	95
UPC/EAN Quiet Zones	96
ADD-ONS	97
Optional Add-ons	97
Optional Add-On Timer	98
Optional GS1-128 Add-On Timer	100
CODE 39	103
Code 39 Enable/Disable	103
Code 39 Check Character Calculation	103
Code 39 Check Character Transmission	104
Code 39 Start/Stop Character Transmission	105
Code 39 Full ASCII	105
Code 39 Quiet Zones	106
Code 39 Length Control	106
Code 39 Set Length 1	107
Code 39 Set Length 2	108
TRIOPTIC CODE	109
Trioptic Code Enable/Disable	109
CODE 32 (ITAL PHARMACEUTICAL CODE)	109
Code 32 Enable/Disable	109
Code 32 Feature Setting Exceptions	109
Code 32 Check Character Transmission	110
Code 32 Start/Stop Character Transmission	110
CODE 39 CIP (FRENCH PHARMACEUTICAL)	111
Code 39 CIP Enable/Disable	111
CODE 39 DANISH PPT	111
Code 39 Danish PPT Enable/Disable	111
CODE 39 LAPOSTE	112
Code 39 LaPoste Enable/Disable	112
CODE 39 PZN	112
Code 39 PZN Enable/Disable	112
CODE 128	113
Code 128 Enable/Disable	113
Expand Code 128 to Code 39	113
Code 128 Check Character Transmission	114
Code 128 Function Character Transmission	114
Code 128 Sub-Code Exchange Transmission	115

Code 128 Quiet Zones	115
Code 128 Length Control	116
Code 128 Set Length 1	117
Code 128 Set Length 2	118
GS1-128	119
GS1-128 Enable	119
GS1-128 2D Component	119
CODE ISBT 128	120
ISBT 128 Concatenation	120
ISBT 128 Force Concatenation	120
ISBT 128 Concatenation Mode	121
ISBT 128 Dynamic Concatenation Timeout	122
ISBT 128 Advanced Concatenation Options	122
INTERLEAVED 2 OF 5 (I 2 OF 5)	123
I 2 of 5 Enable/Disable	123
I 2 of 5 Check Character Calculation	124
I 2 of 5 Check Character Transmission	125
I 2 of 5 Length Control	125
I 2 of 5 Set Length 1	126
I 2 of 5 Set Length 2	127
INTERLEAVED 2 OF 5 CIP HR	128
Interleaved 2 of 5 CIP HR Enable/Disable	128
FOLLETT 2 OF 5	128
Follett 2 of 5 Enable/Disable	128
STANDARD 2 OF 5	129
Standard 2 of 5 Enable/Disable	129
Standard 2 of 5 Check Character Calculation	129
Standard 2 of 5 Check Character Transmission	130
Standard 2 of 5 Length Control	130
Standard 2 of 5 Set Length 1	131
Standard 2 of 5 Set Length 2	132
INDUSTRIAL 2 OF 5	133
Industrial 2 of 5 Enable/Disable	133
Industrial 2 of 5 Check Character Calculation	133
Industrial 2 of 5 Check Character Transmission	134
Industrial 2 of 5 Length Control	134
Industrial 2 of 5 Set Length 1	135
Industrial 2 of 5 Set Length 2	136
CODE IATA	137
IATA Enable/Disable	137
IATA Check Character Transmission	137
CODABAR	138
Codabar Enable/Disable	138
Codabar Check Character Calculation	138
Codabar Check Character Transmission	139
Codabar Start/Stop Character Transmission	139
Codabar Start/Stop Character Set	140
Codabar Start/Stop Character Match	140
Codabar Quiet Zones	141
Codabar Length Control	141
Codabar Set Length 1	142
Codabar Set Length 2	143
ABC CODABAR	144
ABC Codabar Enable/Disable	144
ABC Codabar Concatenation Mode	144
ABC Codabar Dynamic Concatenation Timeout	145
ABC Codabar Force Concatenation	146
CODE 11	147
Code 11 Enable/Disable	147
Code 11 Check Character Calculation	147
Code 11 Check Character Transmission	148
Code 11 Length Control	148
Code 11 Set Length 1	149
Code 11 Set Length 2	150
GS1 DATABAR™ OMNIDIRECTIONAL	151
GS1 DataBar™ Omnidirectional Enable/Disable	151
GS1 DataBar™ Omnidirectional GS1-128 Emulation	151

GS1 DataBar™ Omnidirectional 2D Component	152
GS1 DATABAR™ EXPANDED	152
GS1 DataBar™ Expanded Enable/Disable	152
GS1 DataBar™ Expanded GS1-128 Emulation	153
GS1 DataBar™ Expanded 2D Component	153
GS1 DataBar™ Expanded Length Control	154
GS1 DataBar™ Expanded Set Length 1	155
GS1 DataBar™ Expanded Set Length 2	156
GS1 DATABAR™ LIMITED	157
GS1 DataBar™ Limited Enable/Disable	157
GS1 DataBar™ Limited GS1-128 Emulation	157
GS1 DataBar™ Limited 2D Component	158
CODE 93	158
Code 93 Enable/Disable	158
Code 93 Check Character Calculation	159
Code 93 Check Character Transmission	159
Code 93 Length Control	160
Code 93 Set Length 1	161
Code 93 Set Length 2	162
Code 93 Quiet Zones	163
MSI	163
MSI Enable/Disable	163
MSI Check Character Calculation	164
MSI Check Character Transmission	164
MSI Length Control	165
MSI Set Length 1	166
MSI Set Length 2	167
PLESSEY	168
Plessey Enable/Disable	168
Plessey Check Character Calculation	168
Plessey Check Character Transmission	169
Plessey Length Control	169
Plessey Set Length 1	170
Plessey Set Length 2	171
2D Symbolologies	173
2D Global Features	173
2D Maximum Decoding Time	174
2D Structured Append	175
2D Normal/Inverse Symbol Control	175
AZTEC CODE	176
Aztec Code Enable / Disable	176
Aztec Code Length Control	176
Aztec Code Set Length 1	177
Aztec Code Set Length 2	178
CHINA SENSIBLE CODE	179
China Sensible Code Enable / Disable	179
China Sensible Code Length Control	179
China Sensible Code Set Length 1	180
China Sensible Code Set Length 2	181
DATA MATRIX	182
Data Matrix Enable / Disable	182
Data Matrix Square/Rectangular Style	182
Data Matrix DPM Decoding Safety	183
Data Matrix Length Control	184
Data Matrix Set Length 1	184
Data Matrix Set Length 2	185
MAXICODE	186
Maxicode Enable / Disable	186
Maxicode Primary Message Transmission	186
Maxicode Length Control	187
Maxicode Set Length 1	187
Maxicode Set Length 2	188
PDF417	189
PDF417 Enable / Disable	189
PDF417 Length Control	189
PDF417 Set Length 1	190
PDF417 Set Length 2	191

MICRO PDF417	192
Micro PDF417 Enable / Disable	192
Micro PDF417 Code 128 GS1-128 Emulation	192
Micro PDF417 Length Control	193
Micro PDF417 Set Length 1	193
Micro PDF417 Set Length 2	194
QR CODE	195
QR Code Enable / Disable	195
QR Code Length Control	195
QR Code Set Length 1	196
QR Code Set Length 2	197
MICRO QR CODE	197
Micro QR Code Enable/Disable	197
Micro QR Code Length Control	198
Micro QR Code Set Length 1	198
Micro QR Code Set Length 2	199
UCC COMPOSITE	200
UCC Composite Enable / Disable	200
UCC Optional Composite Timer	201
POSTAL CODE SELECTION	202
Postnet BB Control	203
Motion Features	205
Motion Aiming Control	205
Motion Sensitivity	206
Motionless Timeout	206
Wireless Features	207
WIRELESS BEEPER FEATURES	209
Good Transmission Beep	209
Beep Frequency	209
Beep Duration	210
Beep Volume	211
Disconnect Beep	211
Docking Beep	212
Leash Alarm	212
CONFIGURATION UPDATES	214
Automatic Configuration Update	214
Copy Configuration to Scanner	214
Copy Configuration to Base Station	214
BATCH FEATURES	215
Batch Mode	215
Send Batch	215
Erase Batch Memory	216
RF Batch Mode Transmit Delay	216
DIRECT RADIO AUTOLINK	217
RF ADDRESS STAMPING	217
Source Radio Address Transmission	217
Source Radio Address Delimiter Character	218
REAL TIME CLOCK (RTC) CONFIGURATION	219
Current Date	219
Current Time	219
Date Tx Format	220
Time Tx Format	220
Date-Time Separator	221
Date-Time Transmission Order	222
PBT9500-Only Features	223
BLUETOOTH SECURITY FEATURES	223
Bluetooth Security Mode	224
Bluetooth PIN Code	224
Select PIN Code Length	224
Set PIN Code	225
OTHER BLUETOOTH FEATURES	226
Bluetooth Poll Rate	226
Power Off	227
Powerdown Timeout	227
Bluetooth HID Variable PIN Code	228
Bluetooth HID Alt Mode	229
Bluetooth HID Send Unknown ASCII Char	229

Bluetooth Max Client	230
Bluetooth Friendly Name	231
Bluetooth Reconnect Attempt Mode	231
HID Country Mode	232
PM9500-Only Features.....	235
STAR Radio Protocol Timeout	235
STAR Radio Transmit Mode	236
Changing System Speed	237
Compatibility with PM8500.....	238
Compatibility mode	238
Changing from Normal to Compatible Mode	238
Changing from Compatible Mode back to Normal	239
Base Address Stamping	240
Base Address Delimiter Character	240
RS-485 Master Header/Terminator (Prefix/Suffix)	241
RS-485 Cradle Address	241
RS-485 Slave Minimum Address	242
RS-485 Slave Maximum Address	242
RS-485 Network Working Mode	243
RS-485 Network Warning Message	243
RS-485 Transmission Warning Message	244
RS-485 Network Baud Rate	244
Display and Keyboard Features.....	245
Display Operating Mode	245
Display Off Timeout	246
Backlight Enable	246
Display Contrast	247
Font Size	247
Enable/disable buttons	248
CONFIGURE ACTIONS FOR FUNCTION KEYS	249
Action Configuration for Function Keys	250
Configure Actions for F1	250
Configure Actions for F2	250
Define Strings	251
Set String ID	252
Set String Header	252
Set String Terminator	253
REFERENCES.....	255
RS-232 Parameters	256
RS-232 Only	256
RS-232/USB COM Parameters	257
Keyboard Interface	264
Wedge Quiet Interval	264
Intercharacter Delay	265
Intercode Delay	266
Symbologies	267
Datamatrix DPM Decoding Safety	267
Set Length	267
Data Editing	269
Global Prefix/Suffix	270
Global AIM ID	270
Label ID	272
Character Conversion	277
Reading Parameters	278
Good Read LED Duration	278
Scanning Features	279
Scan Mode	279
Stand Mode Off Time	280
Scanning Active Time	281
Aiming Duration Time	282
Flash On Time	283
Flash Off Time	284
Multiple Labels Ordering by Code Symbology	285
Motion Features	287
Motionless Timeout	287
Wireless Features	288

Contents

Automatic Configuration Update	288
RF Address Stamping	288
PM9500-Only Features	290
Changing System Speed in Normal Mode	290
Bluetooth-Only Features	290
MESSAGE FORMATTING.....	293
Cursor Control	294
Font Selection	294
Clearing Display	294
LED and Beeper Control	295
Setting RTC	295
TECHNICAL SPECIFICATIONS	297
Imager Labeling	301
Standard Cable Pinouts	302
LED and Beeper Indications	303
Error Codes	304
Base Station Indications (Cordless Models ONLY)	304
SAMPLE BAR CODES.....	305
STANDARD DEFAULTS.....	309
KEYPAD.....	323
SCANCODE TABLES.....	325
Control Character Emulation	325
Single Press and Release Keys	325
Interface Type PC AT PS/2, USB-Keyboard or USB-Keyboard for APPLE	326
Interface Type PC AT PS/2 Alt Mode or USB-Keyboard Alt Mode	328
Digital Interface	330
IBM31xx 102-key	331
IBM XT	332
Microsoft Windows Codepage 1252	333



Chapter 1

Introduction

About this Manual

This Product Reference Guide (PRG) is provided for users seeking advanced technical information, including connection, programming, maintenance and specifications. The Quick Reference Guide (QRG) and other publications associated with this product are downloadable free of charge from the website listed on the back cover of this manual.

Overview

[Chapter 1](#), (this chapter) presents information about manual conventions, and an overview of the reader, its features and operation.

[Chapter 2, Setup](#) presents information about unpacking, cable connection information and setting up the reader.

[Chapter 3, Configuration Using Bar Codes](#) provides instructions and bar code labels for customizing your reader. There are different sections for interface types, general features, data formatting, symbology-specific and model-specific features.

[Chapter 4, References](#) provides background information and detailed instructions for more complex programming items.

[Chapter 5, Message Formatting](#) gives details for programming options.

[Appendix A, Technical Specifications](#) lists physical and performance characteristics, as well as environmental and regulatory specifications. It also provides standard cable pinouts and LED/Beeper functions.

[Appendix B, Sample Bar Codes](#) offers sample bar codes for several common symbologies.

[Appendix C, Standard Defaults](#) references common factory default settings for reader features and options.

[Appendix D, Keypad](#) includes numeric bar codes to be scanned for certain parameter settings.

[Appendix E, Scancode Tables](#) lists control character emulation information for Wedge and USB Keyboard interfaces.

Manual Conventions

The following conventions are used in this document:

The symbols listed below are used in this manual to notify the reader of key issues or procedures that must be observed when using the reader:



Notes contain information necessary for properly diagnosing, repairing and operating the reader.



The CAUTION symbol advises you of actions that could damage equipment or property.

References

Current versions of this Product Reference Guide (PRG), Quick Reference Guide (QRG), the Datalogic Aladdin™ Configuration application, and any other manuals, instruction sheets and utilities for this product can be downloaded from the website listed below. Alternatively, printed copies or product support CDs for most products can be purchased through your Datalogic reseller.

Technical Support

Datalogic Website Support

The Datalogic website (www.datalogic.com) is the complete source for technical support and information for Datalogic products. The site offers product support, warranty information, product manuals, product tech notes, software updates, demos, and instructions for returning products for repair.

Reseller Technical Support

An excellent source for technical assistance and information is an authorized Datalogic reseller. A reseller is acquainted with specific types of businesses, application software, and computer systems and can provide individualized assistance.

Telephone Technical Support

If you do not have internet or email access, you may contact Datalogic technical support at (541) 349-8283 or check the back cover of your manual for more contact information.

About the Reader

The PowerScan 2D is a family of feature-rich and rugged area image readers. It is offered in several different models to better fit the different needs of each customer.

The main model categories are:

- PD9530-XX: Corded models.
- PM9500-XX: STAR-System(tm) models.
- PBT9500-XX: Bluetooth models.

Within each category, further differentiating features are available, described by the part number suffix:

- D: models equipped with display
- DPM: models with laser, ink jet and dot peen reading capability
- HP: models with autofocus optic

Typically, units are factory-programmed for the most common terminal and communications settings. If you need to modify any programmable settings, custom configuration can be done by scanning the programming barcodes within this guide or with Datalogic Aladdin™, available from the Datalogic website. See "[Datalogic Aladdin™](#)" on page 6 for more information.

Advancements in the LED technology used in the imager-based readers significantly improve the illumination of the target field of view, resulting in higher scan efficiency. Whether used in Single Trigger or Continuous Mode, the ergonomic design of the reader will help to promote comfortable handling during extended periods of use.

In addition, the reader can be set up to read and output data from USA Driver License PDF417 bar codes. For more information reference the USA Driver License Parsing Quick Reference Guide (QRG), available on the Datalogic website.

See "[Interface Selection](#)" on page 14 for a listing and descriptions of available interface sets by model type.

PM8500 Compatible Mode:

Powerscan PM9500 offers a limited set of features compatible with the previous PM8500 family. To access those features, you have to program the system through the Compatibility Mode parameter (see "[Compatibility mode](#)" on page 238 of the Wireless Configuration chapter).

When in normal mode, the same parameter can be used to configure the communication speed.

The BC9xx0™ Base Station/Charger

The BC9xx0 base station, when paired with one or more PowerScan™ 9500 readers, builds a Cordless Reading System for the collection, decoding and transmission of bar code data. It can be connected to a Host PC via RS-232, USB, or KBD Wedge, and is suited for single-cradle layouts. The BC91x0 models also provide a spare battery charger slot.

The label on the cradle contains LED indicators and a multi-function button. When the button is pressed for less than 5 seconds, the cradle will transmit a "broadcast" message." When the broadcast is sent, all properly configured scanners (Radio RX Timeout set to keep the radio "awake") that are linked to that base and within radio range coverage will emit a beep and blink within 5 seconds. This functionality is useful to:

- verify which scanners are linked to a certain base station
- detect a scanner forgotten somewhere



When the button is pressed for longer than 5 seconds, all paired scanners will be unpaired.

The LEDs signal the BC9xx0-BT status, as shown in [Table 1 on page 4](#).

Table 1. LED Status

LED	STATUS
Aux	Yellow On = BC9xx0 is powered through an external power supply.
Host	Yellow On = BC9xx0 is powered by the Host.
Reader	Green On = the reader battery is completely charged. Red On = the reader battery is charging. Orange Blinking = reader battery fault - replace battery. Red / Green Alternatively Blinking = charging error - see " Error Codes " on page 304. Off = reader not in the cradle or not properly inserted.
Spare (BC91x0 models only)	Green On = the spare battery is completely charged. Orange Blinking = spare battery fault - replace spare battery. Red/Green Alternatively Blinking = charging error - see " Error Codes " on page 304. Off = no spare battery in the housing or battery not fully inserted.
Radio	Yellow Blinking = radio activity.
Ethernet (Ethernet models only)	Green Blinking = Ethernet activity.

See "[Base Station Indications \(Cordless Models ONLY\)](#)" on page 304 for more specific details on the LEDs.

Battery Safety

To reinstall, charge and/or perform any other action on the battery, follow the instructions in this manual.



Before installing the Battery, read "Battery Safety" on this and the following pages. Datalogic recommends annual replacement of rechargeable battery packs to ensure maximum performance.



Do not discharge the battery using any device except for the scanner. When the battery is used in devices other than the designated product, it may damage the battery or reduce its life expectancy. If the device causes an abnormal current to flow, it may cause the battery to become hot, explode or ignite and cause serious injury.

Lithium-ion battery packs may get hot, explode or ignite and cause serious injury if exposed to abusive conditions. Be sure to follow the safety warnings listed below:

- Do not place the battery pack in fire or heat.
- Do not connect the positive terminal and negative terminal of the battery pack to each other with any metal object (such as wire).
- Do not carry or store the battery pack together with metal objects.
- Do not pierce the battery pack with nails, strike it with a hammer, step on it or otherwise subject it to strong impacts or shocks.
- Do not solder directly onto the battery pack.
- Do not expose the battery pack to liquids, or allow the battery to get wet.
- Do not apply voltages to the battery pack contacts.

In the event the battery pack leaks and the fluid gets into your eye, do not rub the eye. Rinse well with water and immediately seek medical care. If left untreated, the battery fluid could cause damage to the eye.



Always charge the battery at 32° – 104° F (0° - 40° C) temperature range.

Use only the authorized power supplies, battery pack, chargers, and docks supplied by your Datalogic reseller. The use of any other power supplies can damage the device and void your warranty.

Do not disassemble or modify the battery. The battery contains safety and protection devices, which, if damaged, may cause the battery to generate heat, explode or ignite.

Do not place the battery in or near fire, on stoves or other high temperature locations.

Do not place the battery in direct sunlight, or use or store the battery inside cars in hot weather. Doing so may cause the battery to generate heat, explode or ignite. Using the battery in this manner may also result in a loss of performance and a shortened life expectancy.

Do not place the battery in microwave ovens, high-pressure containers or on induction cookware.

Immediately discontinue use of the battery if, while using, charging or storing the battery, the battery emits an unusual smell, feels hot, changes color or shape, or appears abnormal in any other way.

Do not replace the battery pack when the device is turned on.

Do not remove or damage the battery pack's label.

Do not use the battery pack if it is damaged in any part.

Battery pack usage by children should be supervised.

As with other types of batteries, Lithium-Ion (LI) batteries will lose capacity over time. Capacity deterioration is noticeable after one year of service whether the battery is in use or not. It is difficult to precisely predict the finite life of a LI battery, but cell manufacturers rate them at 500 charge cycles. In other words, the batteries should be expected to take 500 full dis-

charge / charge cycles before needing replacement. This number is higher if partial discharging / recharging is adhered to rather than full / deep discharging,

The typical manufacturer advertised useful life of LI batteries is one to three years, depending on usage and number of charges, etc., after which they should be removed from service, especially in mission critical applications. Do not continue to use a battery that is showing excessive loss of capacity, it should be properly recycled / disposed of and replaced. For most applications, batteries should be replaced after one year of service to maintain customer satisfaction and minimize safety concerns.

Collect and recycle waste batteries separately from the device in compliance with European Directive 2006/66/EC, 2011/65/EU, 2002/96/EC and 2012/19/EU and subsequent modifications, US and China regulatory and others laws and regulations about the environment.

Programming the Reader

Configuration Methods

Programming Bar Codes

The reader is factory-configured with a standard set of default features. After scanning the interface bar code, you can select other options and customize your reader through use of the instructions and programming bar code labels available in the corresponding features section for your interface. Customizable settings for many features are found in "[Configuration Parameters](#)" starting on page 21.

Some programming labels, like "[Restore Custom Defaults](#)" on page 18, require only the scan of the single label to enact the change. Most, however, require the reader to be placed in Programming Mode prior to scanning them. Scan an ENTER/EXIT bar code once to enter Programming Mode. Once the reader is in Programming Mode, scan a number of parameter settings before scanning the ENTER/EXIT bar code a second time, which will then accept your changes, exit Programming Mode and return the reader to normal operation.



There are some exceptions to the typical programming sequence described above. Please read the description and setting instructions carefully when configuring each programmable feature.

Datalogic Aladdin™

Datalogic Aladdin™ is a multi-platform utility program providing a quick and user-friendly configuration method via the RS-232/USB-COM interface. Aladdin allows you to program the reader by selecting configuration commands through a user-friendly graphical interface running on a PC. These commands are sent to the reader over the selected communication interface, or they can be printed as bar codes to be scanned. Aladdin also facilitates image capturing.

In addition, Aladdin makes it easy to upgrade the handheld's firmware, to attain the benefits of new reader features. Reference the Datalogic Aladdin™ Online Help for more details.

Aladdin is available for download free of charge on the Datalogic website.



Chapter 2 Setup

Unpacking

Check carefully to ensure the reader and any accessories ordered are present and undamaged. If any damage occurred during shipment, contact Datalogic Technical Support. Information is shown on [page 2](#).

KEEP THE PACKAGING. Should the unit ever require service, it should be returned in its original shipping container.

Setting Up the Reader

Follow the steps below to connect and get your reader up and communicating with its host.

1. Begin by Installing the Interface Cable (Corded) or Connecting the Base Station (Bluetooth and STAR)
2. Configure Interface Settings (see [page 14](#)).
3. Configure the Reader starting on [page 17](#) (optional, depends on settings needed)

Connect the PowerScan by plugging directly into the host device as shown. The power can also be supplied through an external power supply via the Interface Cable supplied with a power jack.

Connecting the Cable (Corded versions)

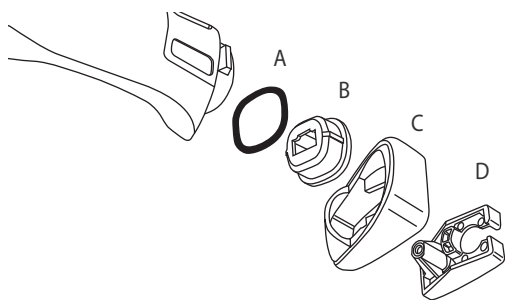

- A. Rubber gasket
- B. Cable Holder
- C. Cover
- D. Connector Holder

1. Slip the cable through the Cover.
2. Push the Rubber Gasket onto the Cable Holder.
3. Push the Cable Holder and gasket into the handle. Ensure that the “Front” marking on the Cable Holder is facing out, with the arrow pointing towards the front of the scanner.
4. Insert the end of the cable into the socket of the Cable Holder.
5. Push the Cover along the cable towards the reader, and hook it over the yellow “tooth” on the back of the handle.
6. Insert the cable through the Connector Holder, and push it up into the Cover.
7. Insert and tighten the screw to affix the cable assembly to the reader handle.

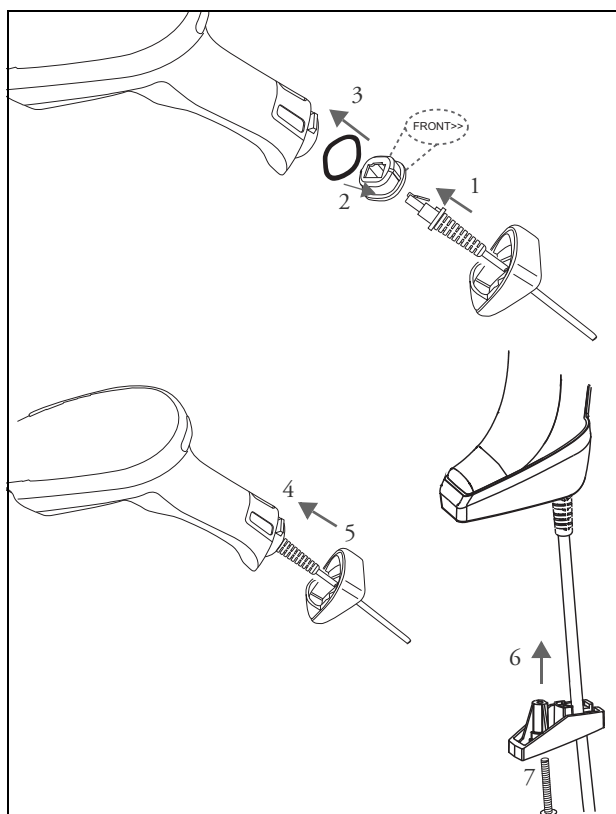

Configuring the Base Station

To set up your BC9xx0 cradle you must:

1. Physically install the cradle.
2. Make all system connections.
3. Configure the BC9xx0 cradle.

Mounting the BC9xx0 Cradle

The cradle package contains the following items:

BC9xx0 Base Station (with Desktop Mounting Bracket installed)	1 Metal Mounting plate
BC9xx0 Quick Reference Guide (this manual)	1 Wall Mounting Bracket

The cradle can be either mounted on a flat surface for desktop usage or affixed vertically to a wall.

Mounting Brackets

The cradle comes with two different mounting brackets. The appropriate bracket is used depending on whether the cradle will be mounted on a horizontal or vertical surface. When shipped, the cradle has the Desktop Mounting Bracket installed. For vertical installation, the Wall Mounting Bracket must be attached instead.

Figure 1. Mounting Brackets

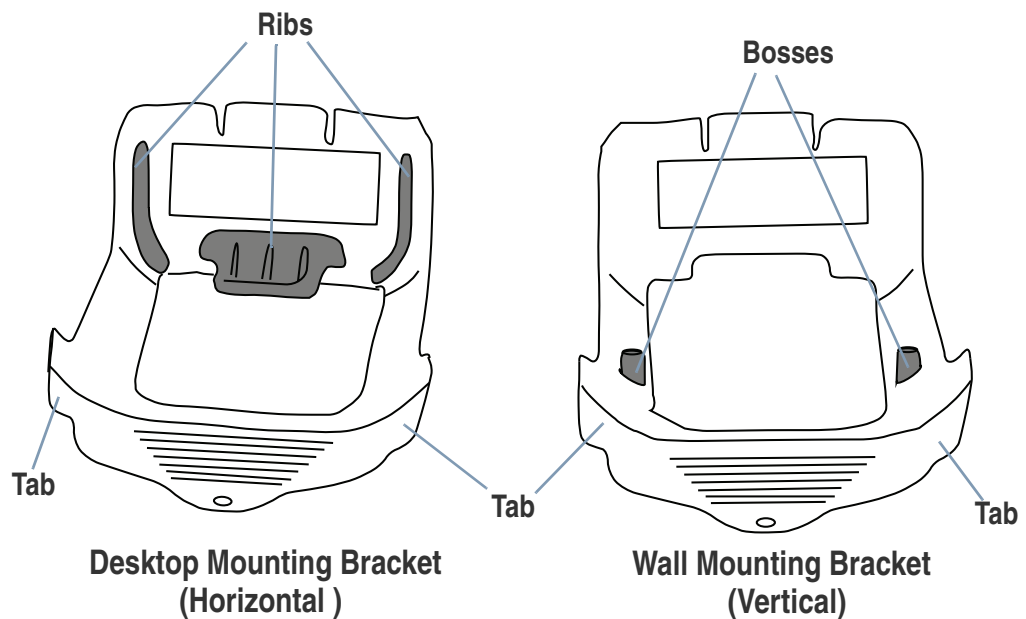

- Desktop mount bracket has ribs to keep the scanner in place when the cradle is horizontal.
- Wall mount bracket contains bosses to keep the scanner in place when the cradle is vertical.

To change the Bracket:

1. Remove the screw holding the Bracket in place. Retain the screw for re-use.
2. Carefully lift off the Bracket.
3. Install the other bracket by first slipping the end tab into place on the base station, then easing the tabs (shown in Figure 1 on page 9) into place on the sides.
4. Replace the screw to secure the Bracket to the Base Station.

Figure 2. Changing the Bracket



Permanent Mounting

For either desktop or wall mounting, the cradle can be fastened directly to a flat surface using screws (not included).



When mounting on drywall, the base should be screwed to a wall stud or supporting beam for additional support.

Figure 3. Base Station Bottom

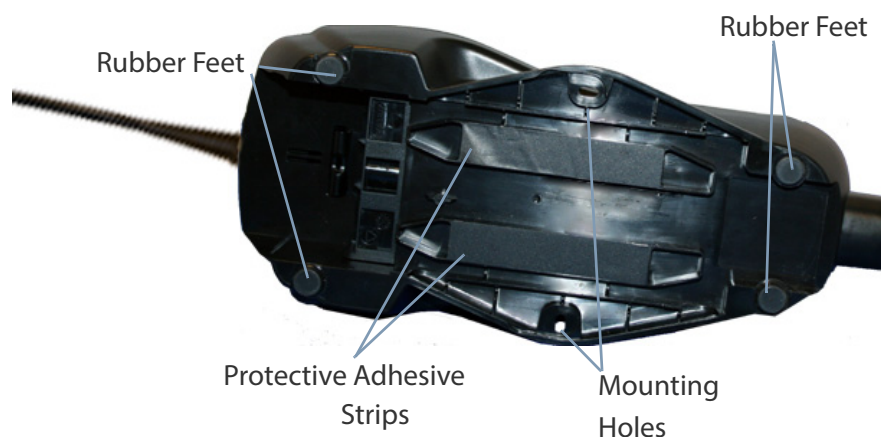

Mounting for Portable Use

If portability of the cradle is required, the metal plate must be used. There are two ways this can be done: (1) by first mounting the metal plate on a flat surface so the cradle can be slid off and on, or (2) mounting the metal plate onto the back of the base station and then screwing both to the desired surface.



For additional security on wall mounting, it is strongly recommended that the cradle be secured into place using two auxiliary screws through the mounting holes on the side.

Mounting the Metal Plate

1. Affix the metal plate onto the desired mounting surface using the two center screw holes (see Figure 4 on page 11).
2. Remove the adhesive strips protecting the mounting tabs on the cradle, shown in Figure 3.
3. Slide the tabs on the back of the cradle onto the metal plate as shown in Figure 4.
4. After aligning the tabs, push up to lock into place.

Figure 4. Mounting Plate on Wall

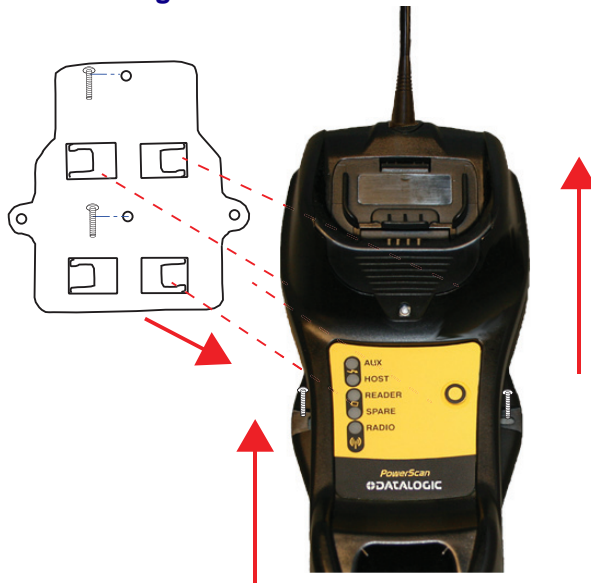

Attaching the Metal Plate to Base

Alternatively, the mount can be attached first to the base, then both can be mounted to a wall as described above.

Figure 5. Attaching Mounting Plate to Base

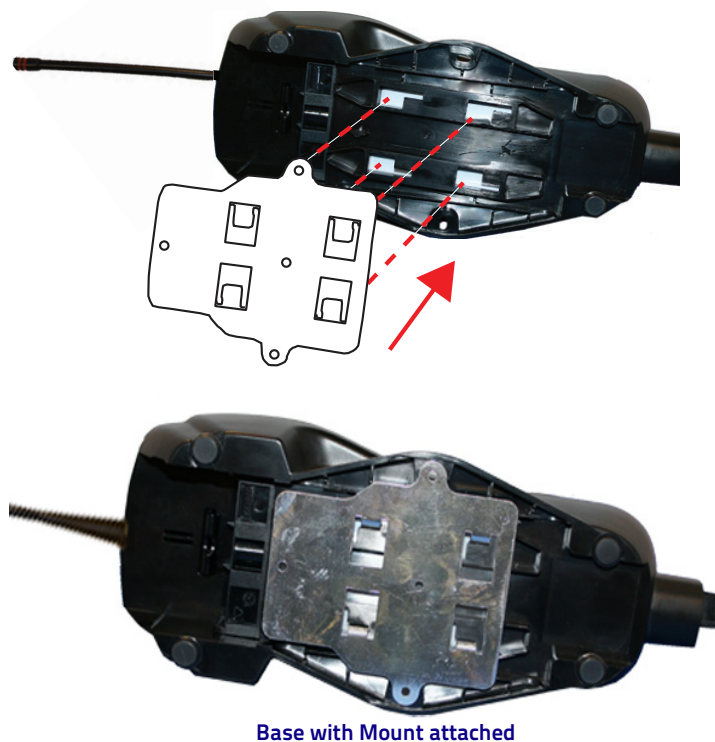

Base with Mount attached

System Connections



Connections should always be made with power off!

The BC9xx0 cradle provides a multi-interface connector and a power supply connector as shown:



Power Supply

Multi-Interface Connector

Connecting and Disconnecting the Interface Cable

The BC9xx0 can be connected to a Host by means of a multi-interface cable, which must be simply plugged into the Host connector, visible on the front panel of the cradle.

To disconnect the cable, insert a paper clip or other similar object into the hole corresponding to the Host connector on the body of the cradle. Push down on the clip while unplugging the cable. Refer to the following figures:

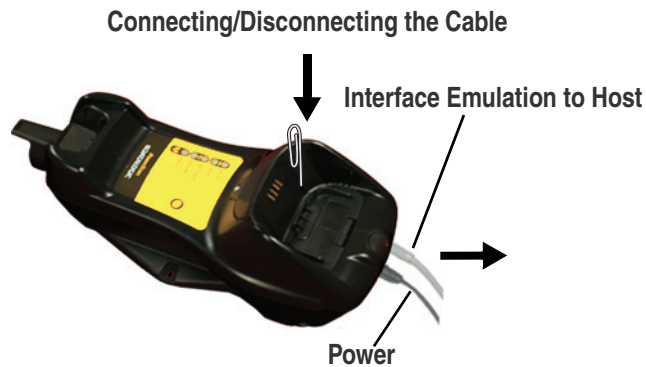

RS-232



USB*



*The power supply is optional, the cradle can be powered by the USB port. In this case the full charging of an empty battery will take about 10 hours. For intense usage and/or when the system is shut down during the night, the use of an external power supply is recommended.

WEDGE

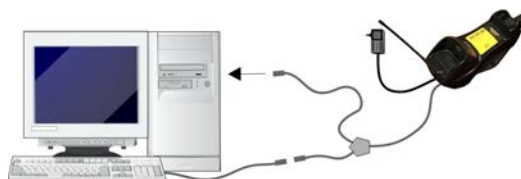

BC9xx0 Configuration

The BC9xx0 configuration can be performed in three ways: by using the Datalogic Aladdin™ software configuration program, by sending configuration strings from the Host PC via the RS-232 or USB-COM interface or by reading configuration bar codes with the PowerScan™ 9500 reader.

Serial Configuration

By connecting the BC9xx0 to a PC through an RS-232 or USB-COM interface cable it is possible to send configuration strings from the PC to BC9xx0.

Configuration Bar Codes

Link the cradle and the reader using the procedures described in the PowerScan™ PM9500 or PBT9500 Quick Reference. Once the pairing is complete, you can configure the BC9xx0 cradle by reading configuration bar codes in this manual.

To configure the BC9xx0 using the PowerScan™ 9500 reader (paired to the cradle with the Bind command), follow the procedure according to the interface selected.

Interface Selection

Upon completing the physical connection between the reader and its host, proceed to [Table 2 on page 15](#) to select the interface type the reader is connected to (for example: RS-232, Keyboard Wedge, USB, etc.). Scan the appropriate bar code in that section to configure your system's correct interface type.

Setting the Interface









Scan the programming bar code from this section which selects the appropriate interface type matching the system the reader will be connected to. Next, proceed to the corresponding section in this manual (also listed in [Table 2 on page 15](#)) to configure any desired settings and features associated with that interface.



Unlike some programming features and options, interface selections require that you scan only one programming bar code label. **DO NOT** scan an ENTER/EXIT bar code prior to scanning an interface selection bar code.

Some interfaces require the scanner to start in the disabled state when powered up. If additional scanner configuration is desired while in this state, pull the trigger and hold it for five seconds. The scanner will change to a state that allows programming with bar codes.

Table 2. Available Interfaces

RS-232		FEATURES
RS-232 standard interface	 Select RS232-STD	Set RS-232 Interface Features starting on page 25
 Select RS232-WN	RS-232 Wincor-Nixdorf	
RS-232 for use with OPOS/UPOS/JavaPOS	 Select RS-232 OPOS	
USB		FEATURES
 Select USB COM-STD ^a	USB Com to simulate RS-232 standard interface	Set USB-OEM Interface Features starting on page 47
USB-OEM (can be used for OPOS/UPOS/JavaPOS)	 Select USB-OEM	
 Select USB Keyboard	USB Keyboard with standard key encoding	
USB Keyboard with alternate key encoding	 Select USB Alternate Keyboard	
 Select USB-KBD-APPLE	USB Keyboard for Apple computers	

a. Download the correct USB Com driver from www.datalogic.com

KEYBOARD	FEATURES
<p>USB Keyboard with alternate key encoding</p>  <p>Select USB Alternate Keyboard</p>	<p>Set KEYBOARD WEDGE Interface Features starting on page 37</p>
 <p>Select USB-KBD-APPLE</p> <p>USB Keyboard for Apple computers</p>	
<p>AT, PS/2 25-286, 30-286, 50, 50Z, 60, 70, 80, 90 & 95 w/Standard Key Encoding</p>  <p>Select KBD-AT</p>	
 <p>Select KBD-AT-NK</p> <p>Keyboard Wedge for IBM AT PS2 with standard key encoding but without external keyboard</p>	
<p>AT, PS/2 25-286, 30-286, 50, 50Z, 60, 70, 80, 90 & 95 w/Alternate Key</p>  <p>Select KBD-AT-ALT</p>	
 <p>Select KBD-AT-ALT-NK</p> <p>Keyboard Wedge for IBM AT PS2 with alternate key encoding but without external keyboard</p>	

Customizing Configuration Settings

Configure Interface Settings

If after scanning the interface bar code from the previous table, your installation requires you to select options to further customize your reader, turn to the appropriate section for your interface type in "Configuration Parameters" starting on page 21.

Global Interface Features

See "Global Interface Features" on page 23 for settings configurable by all interface types.

Configuring Other Features

If your installation requires different programming than the standard factory default settings, the following sections of this manual allow configuration of non-interface-specific settings you might require. Go to [Configuration Using Bar Codes](#), starting on page 21 for a complete list of available options.

Software Version Transmission

The software version of the device can be transmitted over the RS-232 and Keyboard interfaces by scanning the following label.

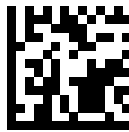

Transmit Software Version

Self Test and Statistics

The internal status of the reader can be accessed in COM interfaces giving the following command string through a Terminal Emulator program:
`$S , yX , s [CR]` (corded reader only).

Resetting the Product Configuration to Defaults

Restore Custom Defaults

If you aren't sure what programming options are in your imager, or you've changed some options and want to restore the Custom Default Configuration that may have been saved in the scanner, scan the Restore Custom Default Configuration bar code below. This will restore the custom configuration for the currently active interface.



Custom defaults are based on the interface type. Configure the imager for the correct interface before scanning this label.



Restore Custom Default Configuration

Restore Factory Configuration

The "Restore Custom Default Configuration" command above is normally enough to restart the machine from a known status (set in the factory or by the customer via configuration file). The machine is set as it arrived to you from the factory or according to the custom configuration file you loaded afterward.

If you want to **permanently cancel** the setup defined by the configuration file use "Restore Factory Configuration" on page 321 of this manual.

The programming items listed in the following sections show the factory default settings for each of the menu commands. If no configuration file has been loaded, the above command restores the factory default.

Set Date and Time

1. Scan the Enter/Exit Programming bar code below to set date and time.



ENTER/EXIT PROGRAMMING MODE

2. Scan the Set Date bar code + six digits for Year, Month and Day (YYMMDD) from [Appendix D, Keypad](#).



Set Date



Set Time

3. Scan Set Time + six digits for Hours, Minutes and Seconds (HHMMSS) from [Appendix D, Keypad](#).

4. Scan the Enter/Exit Programming bar code to complete.

Linking the Reader

Link Datalogic RF Devices to Base

For RF devices, before configuring the interface it is necessary to link the handheld with the base.

To link the handheld and the base, press the trigger to wake up the handheld and mount it into the base. If the reader was previously linked to another base, you must first press and hold the button on the base (>5 seconds), then scan the **Unlink** bar code before re-linking to the new base.

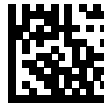

Unlink

Linking to a Bluetooth Adapter in Serial Port Profile (Slave) Mode

1. Install any drivers provided with the Bluetooth adapter.
2. Scan the **Enable RF Link to Server** label below to make the scanner visible to the host computer.
3. Use the host computer's Bluetooth manager to "Discover new devices" and select "Datalogic Scanner." If you receive an error message, it may be necessary to disable security on the device.
4. Use an RS-232 terminal program to see incoming data on the port designated by the computer's Bluetooth manager.



Enable RF Link to Server

Linking to a Bluetooth Adapter in HID mode

1. Install any drivers provided with the Bluetooth adapter.
2. Scan the **Link to PC in HID** label below..
3. Use the host computer's Bluetooth manager to "Discover new devices" and select "Datalogic Scanner." If you receive an error message, it may be necessary to disable security on the device.
4. Use a text editor to see incoming data on the port designated by the computer's Bluetooth manager.



Link to PC in HID



The Powerscan BT9500 can be set up to require a PIN code when connecting. If you want to set up a PIN, or when adding new equipment to a system that uses a custom security PIN, please see "[Bluetooth PIN Code](#)" starting on page 224 for more information.

Power Off

Scan the bar code below to shut off power to the Bluetooth handheld until the next trigger pull. This function only applies to the Bluetooth model.



PowerOff



Chapter 3

Configuration Using Bar Codes

This and following sections provide programming bar codes to configure your reader by changing the default settings. For details about additional methods of programming, see "Configuration Methods" on page 6.



You must first enable your reader to read bar codes in order to use this section. If you have not done this, go to [Setup](#), starting on page 7 and complete the appropriate procedure.

Configuration Parameters

Once the reader is set up, you can change the default parameters to meet your application needs. Refer to "Standard Defaults" starting on page 309 for initial configuration in order to set the default values and select the interface for your application.

The following configuration parameters are divided into logical groups, making it easy to find the desired function based on its reference group.

Interface Configuration:

- "RS-232 Only Interface" on page 25
- "RS-232/USB-Com Interfaces" on page 30
- "Keyboard Settings" on page 37

Parameters common to all interface applications:

- "Data Format" on page 49 gives options to control the messages sent to the Host system by selecting parameters to control the message strings sent to the handheld.
- "Reading Parameters" on page 63 control various operating modes and indicators status functioning such as programming for scanning, beeper and LED indicators and other universal settings.
- "Motion Features" on page 205 provide the ability to configure motion settings for the handheld.

Wireless-Only Features

- Wireless Configuration:
- Wireless beeper features
- Configuration Updates
- Batch Features
- Direct Radio Autolink
- PBT9500 only features
- PM9500 only features



Enter/Exit Programming Mode

- Compatibility with PM8500. programming options for PBT9500 and PM9500 models only.
- Real Time Clock features
- Display and Keyboard features

Symbology-specific parameters:

- "1D Symbologies" on page 81 provides configuration of a personalized mix of 1D codes, code families and their options.
- "2D Symbologies" on page 173 provides configuration of a personalized mix of 2D codes, code families and their options.



You must first enable your reader to read bar codes in order to use this section. If you have not done this, go to [Setup](#), starting on page 7 and complete the appropriate procedure.

To program features:

1. Scan the ENTER/EXIT PROGRAMMING bar code, available at the top of each programming page, when applicable.
2. Scan the bar code to set the desired programming feature. You may need to cover unused bar codes on the page, and possibly the facing page, to ensure that the reader reads only the bar code you intend to scan.
3. If additional input parameters are needed, go to [Appendix D, Keypad](#), and scan the appropriate characters from the keypad.



Additional information about many features can be found in the "References" chapter.

If you make a mistake before the last character, scan the CANCEL bar code to abort and not save the entry string. You can then start again at the beginning.

4. Complete the programming sequence by scanning the ENTER/EXIT PROGRAMMING bar code to exit Programming Mode.

For more detailed descriptions, programming information and examples for setting selected configuration items, see [References](#), starting on page 255.



GLOBAL INTERFACE FEATURES

The following interface features are configurable by all interface types.

Host Commands — Obey/Ignore

This option specifies whether the reader will obey or ignore host commands. When set to ignore, the reader will ignore all host commands except for those necessary for:

- service mode
- flash programming mode
- keeping the interface active
- transmission of labels.

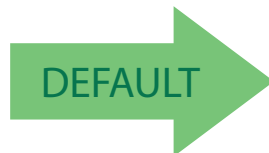

Host Commands = Obey
(Do Not Ignore Host Commands)



Host Commands = Ignore

USB Suspend Mode

This setting enables/disables the ability of USB interfaces to enter suspend mode.

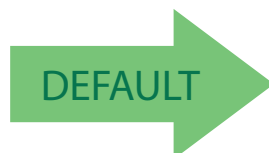

USB Suspend Mode = Disable



USB Suspend Mode = Enable



Enter/Exit Programming Mode

NOTES

RS-232 ONLY INTERFACE

BAUD RATE on page 26
DATA BITS on page 27
STOP BITS on page 27
PARITY on page 28
HANDSHAKING CONTROL on page 29

Use the programming bar codes in this section if modifications to the standard RS-232 interface settings are necessary to meet your system's requirements. Additional settings which apply to both the RS-232 and USB interfaces are available in the next section, "[RS-232/USB-Com Interfaces](#)" starting on page 30.

Reference [Appendix C, Standard Defaults](#) for a listing of standard factory settings.



Baud Rate

See [page 256](#) for information on this feature.



Baud Rate = 1200



Baud Rate = 2400



Baud Rate = 4800



Baud Rate = 9600



Baud Rate = 19,200



Baud Rate = 38,400



Baud Rate = 57,600



Baud Rate = 115,200





Data Bits

This parameter allows the reader to interface with devices requiring a 7-bit or 8-bit ASCII protocol for sending and receiving data.



8 Data Bits



7 Data Bits



Stop Bits

Set the number of stop bits to match host device requirements. See [page 256](#) for more information on this feature.

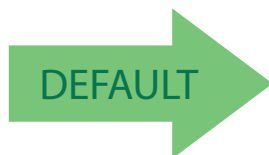

1 Stop Bit



2 Stop Bits



Enter/Exit Programming Mode

Parity

This feature specifies parity required for sending and receiving data. Select the parity type according to host device requirements. See [page 256](#) for more information.

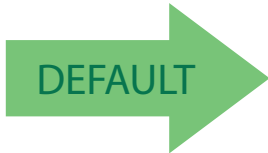

Parity = None



Parity = Even



Parity = Odd



Handshaking Control

See [page 256](#) for more information about this feature.



Handshaking Control = RTS



Handshaking Control = RTS/CTS



Handshaking Control = RTS/XON/XOFF



Handshaking Control = RTS On/CTS



Handshaking Control = RTS/CTS Scan Control

RS-232/USB-COM INTERFACES

INTERCHARACTER DELAY on page 31
BEEP ON ASCII BEL on page 31
BEEP ON NOT ON FILE on page 32
ACK NAK OPTIONS on page 32
ACK CHARACTER on page 33
NAK CHARACTER on page 33
ACK NAK TIMEOUT VALUE on page 34
ACK NAK RETRY COUNT on page 34
ACK NAK ERROR HANDLING on page 35
INDICATE TRANSMISSION FAILURE on page 35
DISABLE CHARACTER on page 36
ENABLE CHARACTER on page 36

The programming bar codes in this chapter allow modifications to the standard RS-232 and USB-Com interfaces. Reference [Appendix C, Standard Defaults](#) for a listing of standard factory settings.



Intercharacter Delay

This parameter specifies the intercharacter delay between the end of one character and the beginning of the next. The delay can be set within a range of zero (0) to 990 milliseconds in 10ms increments. A setting of zero specifies no delay.

See [page 265](#) for more information.



Intercharacter Delay = No Delay

To configure this feature, scan the ENTER/EXIT PROGRAMMING MODE bar code above, then the bar code at left followed by the digits from the Alphanumeric characters in [Appendix D, Keypad](#) representing your desired character(s). End by scanning the ENTER/EXIT bar code again.



Select Intercharacter Delay Setting

Make a mistake? Scan the CANCEL bar code to abort and not save the entry string. You can then start again at the beginning.



CANCEL

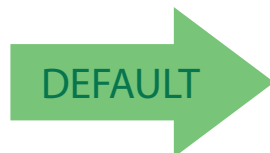

00 = No Intercharacter Delay

Beep On ASCII BEL

When this parameter is enabled, the reader issues a beep when a <BEL> character is detected on the RS-232 serial line. <BEL> is issued to gain a user's attention to an illegal entry or other important event.



Beep On ASCII BEL = Disable



Beep On ASCII BEL = Enable



Beep On Not on File

This option enables/disables the action of the reader to sound a three beep sequence upon receiving a Not-On-File (NOF) host command.



Beep On Not On File = Disable

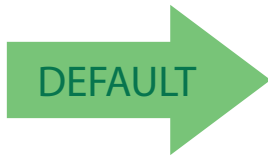

Beep On Not On File = Enable

ACK NAK Options

This enables/disables the ability of the reader to support the RS-232 ACK/NAK protocol.

See [page 258](#) for more information.

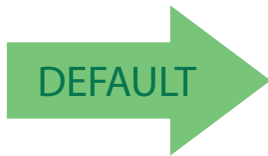

ACK/NAK Protocol = Disable ACK/NAK



ACK/NAK Protocol = Enable for label transmission



ACK/NAK Protocol = Enable for host-command
acknowledge



ACK/NAK Protocol = Enable for label transmission and
host-command acknowledge



ACK Character

This setting specifies an ASCII character or hex value to be used as the ACK character. ASCII characters or any hex value from 0 to 0xFF can be selected. See [page 258](#) for more information.



Setting to previously defined characters such as XON, XOFF, or host commands conflicts with normal operation of these characters. 8-bit data is not recognized when the option [Data Bits](#) has been set as 7 Data Bits.



Select ACK Character Setting



0x06 'ACK' Character

NAK Character

This setting specifies an ASCII character or hex value to be used as the NAK character. ASCII characters or any hex value from 0 to 0xFF can be selected.



Setting to previously defined characters such as XON, XOFF, or host commands conflicts with normal operation of these characters. 8-bit data is not recognized when the option [Data Bits](#) has been set as 7 Data Bits.

See [page 259](#) for more information.



Select NAK Character Setting

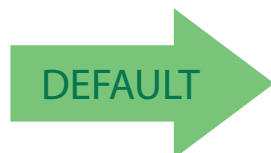

0x15 'NAK' Character



Enter/Exit Programming Mode

ACK NAK Timeout Value

This option specifies the amount of time the reader waits for an ACK character from the host following label transmission. The selectable timeout range is 200 milliseconds to 15,000ms (15 seconds) in 200ms increments. A selection of 0 disables the timeout.

See [page 260](#) for more information on setting this feature.



Select ACK NAK Timeout Value Setting

To configure this feature, scan the ENTER/EXIT PROGRAMMING MODE bar code above, then the bar code at left followed by the digits from the Alphanumeric characters in [Appendix D, Keypad](#) representing your desired character(s). End by scanning the ENTER/EXIT bar code again.

Make a mistake? Scan the CANCEL bar code to abort and not save the entry string. You can then start again at the beginning.



CANCEL

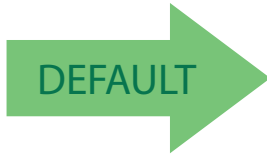

01 ACK NAK Timeout value is 200ms

ACK NAK Retry Count

This feature specifies the number of times the reader retries a label transmission due to a retry condition. The selectable range is from 1 to 254 retries. A selection of 0 disables the count, and a selection of 255 specifies unlimited retries. See [page 261](#) for more information.



Select ACK NAK Retry Count Setting

To configure this feature, scan the ENTER/EXIT PROGRAMMING MODE bar code above, then the bar code at left followed by the digits from the Alphanumeric characters in [Appendix D, Keypad](#) representing your desired character(s). End by scanning the ENTER/EXIT bar code again.

Make a mistake? Scan the CANCEL bar code to abort and not save the entry string. You can then start again at the beginning.



CANCEL

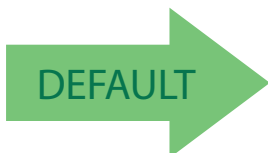

003 = 3 Retries



ACK NAK Error Handling

This feature specifies the method the reader uses to handle receive errors detected while waiting for an ACK character from the host.

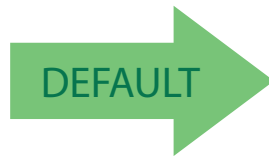

ACK NAK Error Handling = Ignore Errors Detected



ACK NAK Error Handling = Process Error as Valid ACK Character



ACK NAK Error Handling = Process Error as Valid NAK Character

Indicate Transmission Failure

This option enables/disables the reader's ability to sound an error beep to indicate a transmission failure while in ACK/NAK mode.



Indicate Transmission Failure = Disable Indication



Indicate Transmission Failure = Enable Indication





Disable Character

Specifies the value of the RS-232 host command used to disable the reader. ASCII characters or any hex value from 0 to 0xFF can be selected.



Setting to previously defined characters such as XON, XOFF, or host commands conflicts with normal operation of these characters. 8-bit data is not recognized when the option **Data Bits** has been set as 7 Data Bits.

See [page 262](#) for more information on setting this feature.



Select Disable Character Setting

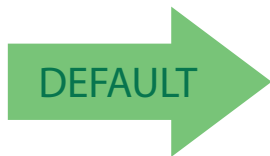

0x44 = Disable Character is 'D'

Enable Character

Specifies the value of the RS-232 host command used to enable the reader. ASCII characters or any hex value from 0 to 0xFF can be selected.



Setting to previously defined characters such as XON, XOFF, or host commands conflicts with normal operation of these characters. 8-bit data is not recognized when the option **Data Bits** has been set as 7 Data Bits.

See [page 263](#) in “References” for more information on setting this feature.



Select Enable Character Setting

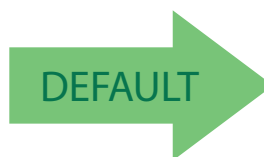

0x45 = Enable Character is 'E'

KEYBOARD SETTINGS

COUNTRY MODE on page 38
SEND CONTROL CHARACTERS on page 41
WEDGE QUIET INTERVAL on page 42
INTERCODE DELAY on page 42
CAPS LOCK STATE on page 43
NUMLOCK on page 43
USB KEYBOARD SPEED on page 44
USB KEYBOARD NUMERIC KEYPAD on page 45

Use the programming bar codes in this chapter to select options for USB Keyboard and Wedge Interfaces. Reference [Appendix C, Standard Defaults](#) for a listing of standard factory settings.

Information about control character emulation which applies to keyboard interfaces is listed in [Appendix E, Scancode Tables](#).



Enter/Exit Programming Mode

Country Mode

This feature specifies the country/language supported by the keyboard. Several languages are supported:

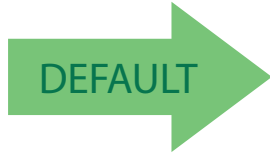

Country Mode = U.S.



Country Mode = Belgium



Country Mode = Britain

Supports only the interfaces listed in the Country Mode feature description.



Country Mode = Croatia

Supports only the interfaces listed in the Country Mode feature description.



Country Mode = Czech Republic



Country Mode = Denmark

Supports only the interfaces listed in the Country Mode feature description.



Country Mode = France



Country Mode (continued)

Supports only the interfaces listed in the Country Mode feature description.



Country Mode = French Canadian



Country Mode = Germany

Supports only the interfaces listed in the Country Mode feature description.



Country Mode = Hungary



Country Mode = Italy

Supports only the interfaces listed in the Country Mode feature description.



Country Mode = Japanese 106-key



Country Mode = Lithuanian

Supports only the interfaces listed in the Country Mode feature description.



Country Mode = Norway



Enter/Exit Programming Mode

Country Mode (continued)



Country Mode = Poland

Supports only the interfaces listed in the Country Mode feature description.

Supports only the interfaces listed in the Country Mode feature description.



Country Mode = Portugal



Country Mode = Romania

Supports only the interfaces listed in the Country Mode feature description.

Supports only the interfaces listed in the Country Mode feature description.



Country Mode = Slovakia



Country Mode = Spain



Country Mode = Sweden



Country Mode = Switzerland

Supports only the interfaces listed in the Country Mode feature description.



Send Control Characters

This feature specifies how the reader transmits ASCII control characters to the host. Reference [Appendix E, Scancode Tables](#) for more information about control characters.

Options are as follows:

Control Character 00 : Characters from 00 to 0x1F are sent as control character Ctrl+Keys, special keys are located from 0x80 to 0xA1.

Control Character 01 : Characters from 00 to 0x1F are sent as control character Ctrl+Shift, special keys are located from 0x80 to 0xA1.

Control Character 02 : Special keys are located from 00 to 0x1F and characters from 0x80 to 0xFE are intended as an extended ASCII table (see "[Microsoft Windows Codepage 1252](#)" on page 333).



Wedge Send Control Characters = 00



Wedge Send Control Characters = 01



Wedge Send Control Characters = 02



Wedge Quiet Interval

Specifies amount of time to look for keyboard activity before scanner breaks keyboard connection in order to transmit data to host. The selectable range for this setting is 00 to 990 milliseconds (00–0x63 by 01) in increments of ten milliseconds. See page 264 in “References” for detailed information and examples for setting this feature.



Set Wedge Quiet Interval

To configure this feature, scan the ENTER/EXIT PROGRAMMING MODE bar code above, then the bar code at left followed by the digits from the Alphanumeric characters in [Appendix D, Keypad](#) representing your desired character(s). End by scanning the ENTER/EXIT bar code again.

Make a mistake? Scan the CANCEL bar code to abort and not save the entry string. You can then start again at the beginning.



CANCEL

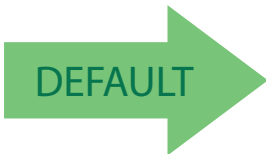

0A = Quiet Interval is 100 milliseconds

Intercode Delay

Specifies the delay between labels transmitted to the host for this interface. The selectable range for this feature is from 0 to 99 seconds.

See page 266 in “References” for detailed information and examples for setting this feature.



Set Intercode Delay

To configure this feature, scan the ENTER/EXIT PROGRAMMING MODE bar code above, then the bar code at left followed by the digits from the Alphanumeric characters in [Appendix D, Keypad](#) representing your desired character(s). End by scanning the ENTER/EXIT bar code again.

Make a mistake? Scan the CANCEL bar code to abort and not save the entry string. You can then start again at the beginning.



CANCEL

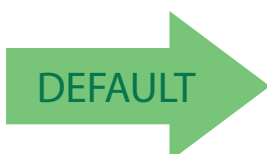

00 = No Wedge Intercode Delay



Caps Lock State

This option specifies the format in which the reader sends character data. This does not apply when an alternate key encoding keyboard is selected.

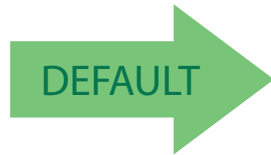

Caps Lock State = Caps Lock OFF



Caps Lock State = Caps Lock ON



Caps Lock State = AUTO Caps Lock Enable

Numlock

This option specifies the setting of the NUMLOCK key in the Keyboard Wedge interface.

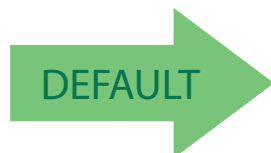

Numlock = NUMLOCK key unchanged



Numlock = Numlock key toggled



USB Keyboard Speed

This option specifies the USB poll rate for a USB keyboard.



This feature applies **ONLY** to the USB Keyboard interface.

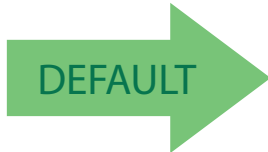

USB Keyboard Speed = 1ms



USB Keyboard Speed = 2ms



USB Keyboard Speed = 3ms



USB Keyboard Speed = 4ms



USB Keyboard Speed = 5ms



USB Keyboard Speed = 6ms



USB Keyboard Speed (continued)



USB Keyboard Speed = 7ms



USB Keyboard Speed = 8ms



USB Keyboard Speed = 9ms



USB Keyboard Speed = 10ms

USB Keyboard Numeric Keypad

This option Controls whether numeric characters will be sent using standard keys or the numeric keypad.

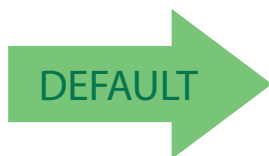

Standard Keys



Numeric Keypad



Enter/Exit Programming Mode

NOTES

USB-OEM INTERFACE

USB-OEM DEVICE USAGE on page 48

INTERFACE OPTIONS on page 48

Feature settings for USB interfaces differ depending upon which host type the reader will be connected with. Use the feature settings in this chapter to specifically configure for the USB-OEM interface. Other USB interfaces are included in the appropriate chapter for their host type.

Reference [Appendix C](#) for a listing of standard factory settings.



USB-OEM Device Usage

The USB-OEM protocol allows for the reader to be identified as one of two different types of bar code scanners. Depending on what other scanners you may already have connected to a USB-OEM POS, you may need to change this setting to enable all devices to communicate.

Options are:

- Table Top Scanner
- Handheld Scanner



It may be necessary to switch device usage when connecting two readers/scanners of the same type to a POS system.



USB-OEM Device Usage = Table Top Scanner



USB-OEM Device Usage = Handheld Scanner



Interface Options

This feature provides for an interface-specific control mechanism.



Obey Scanner Configuration Host Commands



Ignore Scanner Configuration Host Commands



DATA FORMAT

GLOBAL PREFIX/SUFFIX (HEADER/TERMINATOR) on page 50
GLOBAL AIM ID on page 51
LABEL ID starting on page 55 <ul style="list-style-type: none">•Label ID: Pre-Loaded Sets•Individually Set Label ID•Label ID Control•Label ID Symbology Selection – 1D Symbologies•Label ID Symbology Selection – 2D Symbologies
CASE CONVERSION on page 61
CHARACTER CONVERSION on page 61



CAUTION

It is not recommended to use these features with IBM interfaces.

The features in this chapter can be used to build specific user-defined data into a message string. See “References” starting on [page 269](#) for more detailed instructions on setting these features.



Global Prefix/Suffix (Header/Terminator)

This option sets up to 20 characters each from the set of ASCII characters or any hex value from 00 to FF. The characters may be added as a prefix (in a position before the bar code data, also called a header) and/or as a suffix (in a position following the bar code data, also called a terminator). See [page 270](#) for more detailed instructions on setting this feature.

To configure this feature, scan the ENTER/EXIT PROGRAMMING MODE bar code above to place the unit in Programming Mode, then the “Set Global Prefix” or “Set Global Suffix,” bar code followed by the digits (in hex) from the Alphanumeric characters in [Appendix D, Keypad](#) representing your desired character(s). If less than the expected string of 20 characters are selected, scan the ENTER/EXIT bar code to terminate the string. Exit programming mode by scanning the ENTER/EXIT bar code again.



Set Global Prefix



Set Global Suffix

Make a mistake? Scan the CANCEL bar code to abort and not save the entry string. You can then start again at the beginning.



CANCEL

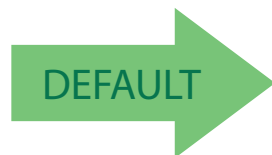

No Global Prefix
Global Suffix = 0x0D (CR)



Global AIM ID



This feature enables/disables addition of AIM IDs for all symbology types.

AIM label identifiers (as opposed to custom characters you select yourself as with label identifiers) can be included with scanned bar code data. See [Table 3 on page 51](#) for a listing of AIM IDs.

AIM label identifiers consist of three characters as follows:

- A close brace character (ASCII ']'), followed by...
- A code character (see some samples in the table below), followed by...
- A modifier character (the modifier character is symbol dependent).

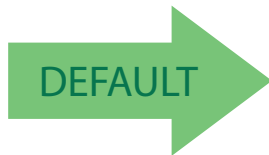

Global AIM ID = Disable



Global AIM ID = Enable

Table 3. AIM IDs

Tag Name	AIM ID code character	AIM ID code ASCII value
ABC CODABAR	X	58
ANKER PLESSEY	N	4E
AZTEC	z	7A
CHINA SENSIBLE CODE	X	58
CODABAR	F	46
CODE11	H	48
CODE128	C	43
CODE32	A	41
CODE39	A	41
CODE39 CIP	X	58
CODE39 DANISH PPT	X	58



Enter/Exit Programming ModeGlobal AIM ID

CODE39 LAPOSTE	X	58
CODE39 PZN	X	58
CODE93	G	47
DATABAR 14	e	65
DATABAR 14 COMPOSITE	e	65
DATABAR EXPANDED	e	65
DATABAR EXPANDED COMPOSITE	e	65
DATABAR LIMITED	e	65
DATABAR LIMITED COMPOSITE	e	65
DATA MATRIX	d	64
EAN128	C	43
EAN128 COMPOSITE	C	43
EAN13	E	45
EAN13 P2	E	45
EAN13 P5	E	45
EAN13 COMPOSITE	E	45
EAN8	E	45
EAN8 P2	E	45
EAN8 P5	E	45
EAN8 COMPOSITE	E	45
FOLLET 2OF5	X	58
I2OF5	I	49
IATA INDUSTRIAL 2OF5	X	58
INDUSTRIAL 2OF5	X	58
ISBN	X	58
ISBT128 CONCAT	X	58
ISSN	X	58
MAXICODE	U	55
MICRO QR	Q	51



MICRO PDF	L	4C
MSI	M	4D
PDF417	L	4C
PLESSEY	P	50
POSTAL AUSTRALIAN	X	58
POSTAL IMB	X	58
POSTAL JAPANESE	X	58
POSTAL KIX	X	58
POSTAL PLANET	X	58
POSTAL PORTUGAL	X	58
POSTAL POSTNET BB	X	58
POSTAL ROYAL MAIL	X	58
POSTAL SWEDISH	X	58
POSTNET	X	58
QR CODE	Q	51
S25	S	53
TRIOPTIC	X	58
UPCA	E	45
UPCA P2	E	45
UPCA P5	E	45
UPCA COMPOSITE	E	45
UPCE	E	45
UPCE P2	E	45
UPCE P5	E	45
UPCE COMPOSITE	E	45



Set AIM ID Individually for GS1-128

This feature configures a Label ID individually for the GS1-128 symbology and the programming for this works the same way as Label ID. See [Label ID: Set Individually Per Symbology](#), starting on page 275 for detailed instructions on setting this feature.



Set AIM ID Individually for GS1-128 = Disable



Set AIM ID Individually for GS1-128 = Enable





Label ID

A Label ID is a customizable code of up to three ASCII characters (convert to Hex using the ASCII Chart on the inside back cover of this manual), used to identify a bar code symbology type. It can be appended previous to or following the transmitted bar code data depending upon how this option is enabled. This feature provides options for configuring custom Label IDs or individually per symbology (see "[Individually Set Label ID](#)" on page 56). If you wish to program the reader to always include an industry standard label identifier for ALL symbology types, see the previous feature "[Global AIM ID](#)" on page 51.

See [Label ID](#), starting on page 272 of "References" for more information on setting this feature.

Label ID: Pre-Loaded Sets

The reader supports two pre-loaded sets of Label IDs. See [Label ID: Pre-loaded Sets](#), starting on page 272 for details on the USA set and EU set.



CAUTION

When changing from one Label ID set to another, all other reader configuration settings, including the host interface type, will be erased and set to the standard factory defaults. Any custom configuration or custom defaults will be lost.



Label ID Pre-loaded Set = USA Set



Label ID Pre-loaded Set = EU Set





Individually Set Label ID

This feature configures a Label ID individually for a single symbology. To set, first define whether you want it as a prefix or suffix by scanning a label below. Then turn to [Label ID Symbology Selection – 1D Symbologies](#), starting on page 57 to select the symbology you want to set, followed by up to 3 characters from the ASCII Chart at the back of this manual. See "[Label ID: Set Individually Per Symbology](#)" on page 275 for detailed instructions on setting this feature.

Label ID Control

This option controls whether a Label ID is disabled, or sent as a prefix or suffix for a given symbology type.

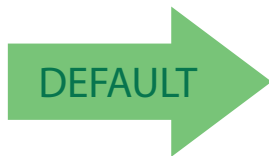

Label ID Transmission = Disable



Label ID Transmission = Enable as Prefix



Label ID Transmission = Enable as Suffix



Label ID Symbology Selection – 1D Symbologies

This option selects the symbology for which a Label ID is to be configured. See "Label ID" on page 55 or page 275 in "References" for more detailed instructions.



If less than the expected string of 3 characters are selected, scan the ENTER/EXIT bar code twice to accept the selection and exit Programming Mode.



Set ABC Codabar Label ID Character(s)



Set Code 32 Pharmacode Label ID Character(s)



Set Anker Plessey Label ID Character(s)



Set Code 93 Label ID Character(s)



Set Australian Postal Code Label ID Character(s)



Set Concatenated ISBT 128 Label ID Character(s)



Set Codabar Label ID Character(s)



Set Danish PPT Label ID Character(s)



Set Code 11 Label ID Character(s)



Set EAN 13 Label ID Character(s)



Set Code 128 Label ID Character(s)



Set EAN 13 Composite Label ID Character(s)



Set Code 39 Label ID Character(s)



Set EAN 13 P2 Label ID Character(s)



Set Code 39 CIP Label ID Character(s)



Set EAN 13 P5 Label ID Character(s)



Label ID Symbology Selection – 1D Symbologies (continued)



Set EAN 8 Label ID Character(s)



Set GS1 DataBar Expanded Composite Label ID Character(s)



Set EAN 8 Composite Label ID Character(s)



Set GS1-128 Label ID Character(s)



Set EAN 8 P2 Label ID Character(s)



Set GS1-128 Composite Label ID Character(s)



Set EAN 8 P5 Label ID Character(s)



Set GSI DataBar Limited Label ID Character(s)



Set Follett 2 of 5 Label ID Character(s)



GSI DataBar Limited Composite Label ID Character(s)



Set GS1 DataBar 14 Label ID Character(s)



Set GTIN 2 Label ID Character(s)



Set GS1 DataBar 14 Composite Label ID Character(s)



Set GTIN 5 Label ID Character(s)



Set GS1 DataBar Expanded Label ID Character(s)



Set GTIN 8 Label ID Character(s)



Set IATA Industrial 2 of 5 Label ID Character(s)



Set LaPoste Code 39 Label ID Character(s)



Label ID Symbology Selection – 1D Symbologies (continued)



Set IMB Postal Code Label ID Character(s)



Set MSI Label ID Character(s)



Set Industrial 2 of 5 Label ID Character(s)



Set Planet Postal Code Label ID Character(s)



Set Interleaved 2 of 5 Label ID Character(s)



Set Plessey Label ID Character(s)



Set ISBN Label ID Character(s)



Set Portugal Postal Code Label ID Character(s)



Set ISSN Label ID Character(s)



Set Postnet Label ID Character(s)



Set Japan Postal Code Label ID Character(s)



Set Kix Postal Code Label ID Character(s)



Set PZN Code Label ID Character(s)



Set Postnet BB Label ID Character(s)



Set Royal Postal Code Label ID Character(s)



Set UPC-A Composite Label ID Character(s)



Set Standard 2 of 5 Label ID Character(s)



Set UPC-A P2 Label ID Character(s)



Label ID Symbology Selection – 1D Symbologies (continued)



Set Swedish Postal Code Label ID Character(s)



Set UPC-A P5 Label ID Character(s)



Set Trioptic Code Label ID Character(s)



Set UPC-E Label ID Character(s)



Set UPC-A Label ID Character(s)



Set UPC-E P5 Label ID Character(s)

Label ID Symbology Selection – 2D Symbologies



Set Aztec Label ID Character(s)



Set Maxicode Label ID Character(s)



Set China Sensible Label ID Character(s)



Set PDF 417 Label ID Character(s)



Set Codablock F Label ID Character(s)



Set Micro PDF 417 Label ID Character(s)



Set Data Matrix Label ID Character(s)



Set QR Code Label ID Character(s)



Set Micro QR Label ID Character(s)

Advanced Formatting: User Label Edit

Advanced formatting is available to create user label edit scripts. See the Datalogic Aladdin configuration application or contact Technical Support.

Case Conversion

This feature allows conversion of the case of all alphabetic characters to upper or lower case.



Case conversion affects **ONLY** scanned bar code data, and does not affect Label ID, Prefix, Suffix, or other appended data.

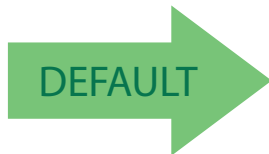

Case Conversion = Disable (no case conversion)



Case Conversion = Convert to upper case



Case Conversion = Convert to lower case

Character Conversion

Character conversion is an eight byte configuration item. The eight bytes are 4 character pairs represented in hexadecimal ASCII values. The first character in the pair is the character that will be converted. The second character in the pair is the character to convert to. If the character to convert in a pair is FF, then no conversion is done.



If less than the expected string of 16 characters are selected, scan the ENTER/EXIT bar code twice to accept the selections and exit Programming Mode.



Configure Character Conversion

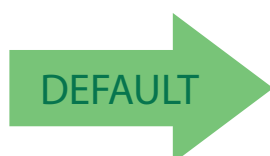

0xFFFFFFFFFFFFFFF
(No character conversion)

NOTES

READING PARAMETERS

DOUBLE READ TIMEOUT on page 64	SCANNING ACTIVE TIME on page 74
LED AND BEEPER INDICATORS on page 66	STAND ILLUMINATION CONTROL on page 74
POWER ON ALERT on page 66	FLASH ON TIME on page 75
GOOD READ: WHEN TO INDICATE on page 66	FLASH OFF TIME on page 75
GOOD READ BEEP TYPE on page 67	AIMING POINTER on page 76
GOOD READ BEEP FREQUENCY on page 67	AIMING DURATION TIMER on page 76
GOOD READ BEEP LENGTH on page 68	GREEN SPOT DURATION on page 77
GOOD READ BEEP VOLUME on page 69	PARTIAL LABEL READING CONTROL on page 77
GOOD READ LED DURATION on page 70	DECODE NEGATIVE IMAGE on page 78
SCAN MODE on page 71	IMAGE CAPTURE on page 78
STAND MODE INDICATION on page 72	MULTIPLE LABELS PER FRAME on page 79
PICK MODE on page 72	MULTIPLE LABELS ORDERING BY CODE SYMBOLOGY on page 80
STAND MODE SENSITIVITY on page 73	MULTIPLE LABELS ORDERING BY CODE LENGTH on page 80
STAND MODE ILLUMINATION OFF TIME on page 73	



Double Read Timeout

Double Read Timeout prevents a double read of the same label by setting the minimum time allowed between reads of labels of the same symbology and data. If the unit reads a label and sees the same label again within the specified timeout, the second read is ignored. Double Read Timeout does not apply to scan modes that require a trigger pull for each label read.



Double Read Timeout = 0.1 Second



Double Read Timeout = 0.2 Second



Double Read Timeout = 0.3 Second



Double Read Timeout = 0.4 Second



Double Read Timeout = 0.5 Second



Double Read Timeout = 0.6 Second



Double Read Timeout = 0.7 Second



Double Read Timeout (continued)



Double Read Timeout = 0.8 Second



Double Read Timeout = 0.9 Second



Double Read Timeout = 1 Second



LED AND BEEPER INDICATORS

Power On Alert

Disables or enables the indication (from the Beeper) that the reader is receiving power.



Power On Alert = Disable (No Audible Indication)



Power On Alert = Power-up Beep



Good Read: When to Indicate

This feature specifies when the reader will provide indication (beep and/or flash its green LED) upon successfully reading a bar code.

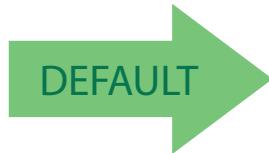

Indicate Good Read = After Decode



Indicate Good Read = After Transmit



Indicate Good Read =
After CTS goes inactive then active



Good Read Beep Type

Specifies whether the good read beep has a mono or bitonal beep sound.

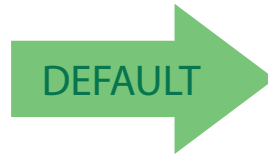

Good Read Beep Type = Mono



Good Read Beep Type = Bitonal

Good Read Beep Frequency

Adjusts the good read beep to sound at a selectable low, medium or high frequency, selectable from the list below. (Controls the beeper's pitch/ tone.)



Good Read Beep Frequency = Low

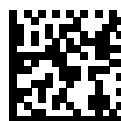

Good Read Beep Frequency = Medium

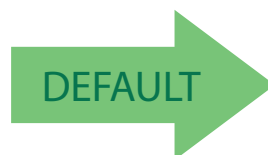

Good Read Beep Frequency = High



Good Read Beep Length



Good Read Beep Length = 60 msec



Good Read Beep Length = 80 msec



Good Read Beep Length = 100 msec



Good Read Beep Length = 120 msec



Good Read Beep Length = 140 msec



Good Read Beep Length = 160 msec



Good Read Beep Length = 180 msec



Good Read Beep Length = 200 msec



Good Read Beep Volume

Selects the beeper volume (loudness) upon a good read beep. There are three selectable volume levels.

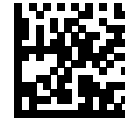

Good Read Beep Volume = Beeper Off



Good Read Beep Volume = Low



Good Read Beep Volume = Medium



Good Read Beep Volume = High





Good Read LED Duration

This feature specifies the amount of time that the Good Read LED remains on following a good read. The good read LED on time can be set within a range of 100 milliseconds to 25,500 milliseconds (0.1 to 25.5 seconds) in 100ms increments. A setting of 00 keeps the LED on until the next trigger pull.

See [page 278](#) in “References” for detailed instructions and examples for setting this feature.



Good Read LED Duration Setting =
Keep LED on until next trigger pull



Select Good Read LED Duration Setting

To configure this feature, scan the ENTER/EXIT PROGRAMMING MODE bar code above, then the bar code at left followed by the digits from the Alphanumeric characters in [Appendix D, Keypad](#) representing your desired character(s). End by scanning the ENTER/EXIT bar code again.

Make a mistake? Scan the CANCEL bar code to abort and not save the entry string. You can then start again at the beginning.



CANCEL



003 = Good Read LED stays on for 300 ms.



Indicators are dimmed during sleep.



SCANNING FEATURES

Scan Mode

Selects the reader's scan operating mode. See [page 279](#) in "References" for descriptions.

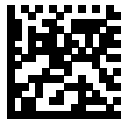

Scan Mode = Trigger Single



DEFAULT



Scan Mode = Trigger Hold Multiple



Scan Mode = Trigger Pulse Multiple



Scan Mode = Flashing



Scan Mode = Always On



Scan Mode = Stand Mode



Stand Mode Indication

This operation is useful for indicating when the reader is in Stand Mode. If enabled, the blue indicator will blink when Stand Mode scanning is active.

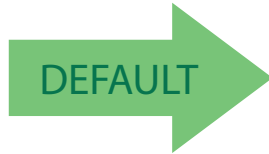

Stand Mode Indication = Disable



Stand Mode Indication = Enable

Pick Mode

Specifies the ability of the reader to decode labels only when they are close to the center of the aiming pattern. This allows the reader to accurately target labels when they are placed close together, such as on a pick sheet.



This feature is not compatible with Multiple Labels Reading in a Volume.

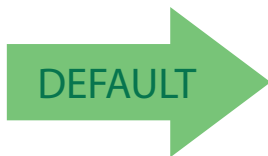

Pick Mode = Disable



Pick Mode = Enable



Stand Mode Sensitivity

Sets the sensitivity level for stand mode wakeup. Choices are low, medium and high.

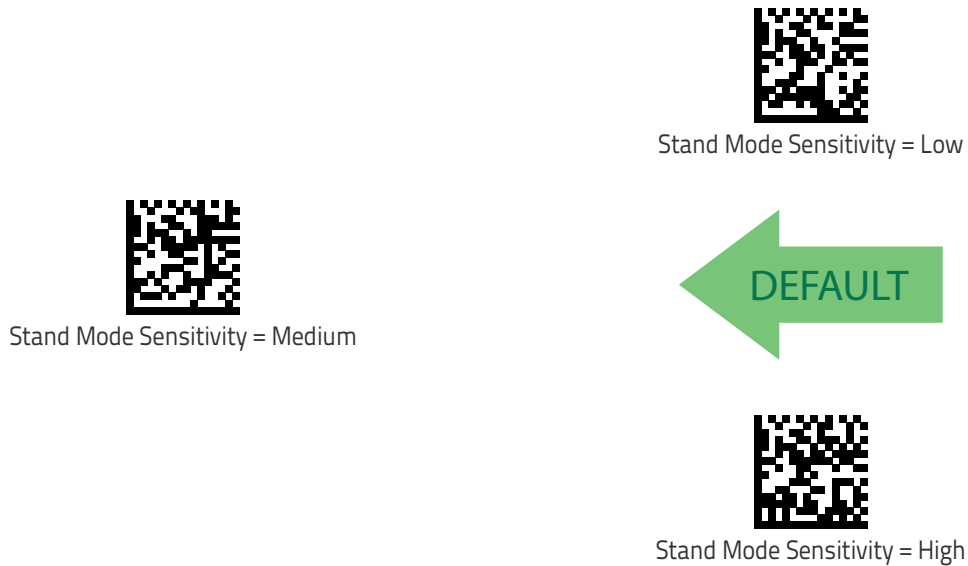

Stand Mode Illumination Off Time

Specifies the amount of time reader illumination stays off after pulling the trigger when in Stand Mode. The configurable range is 01 to 32 by 01 in increments of 500ms (500ms to 16 seconds). See [page 280](#) in “References” for a description of this feature.



To configure this feature, scan the ENTER/EXIT PROGRAMMING MODE bar code above, then the bar code at left followed by the digits from the Alphanumeric characters in [Appendix D, Keypad](#) representing your desired character(s). End by scanning the ENTER/EXIT bar code again.





Scanning Active Time

This setting specifies the amount of time that the reader stays in scan ON state once the state is entered. The range for this setting is from 1 to 255 seconds in 1-second increments. See [page 281](#) in “References” for further description of this feature.

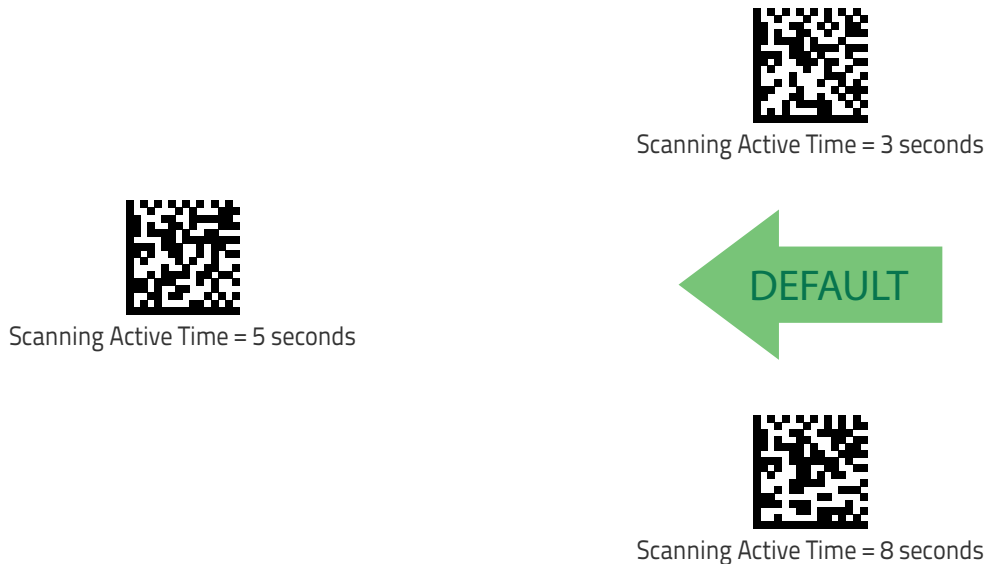

Stand Illumination Control

Controls the illumination status while the reading mode is stand mode and the reader is attempting to detect objects.

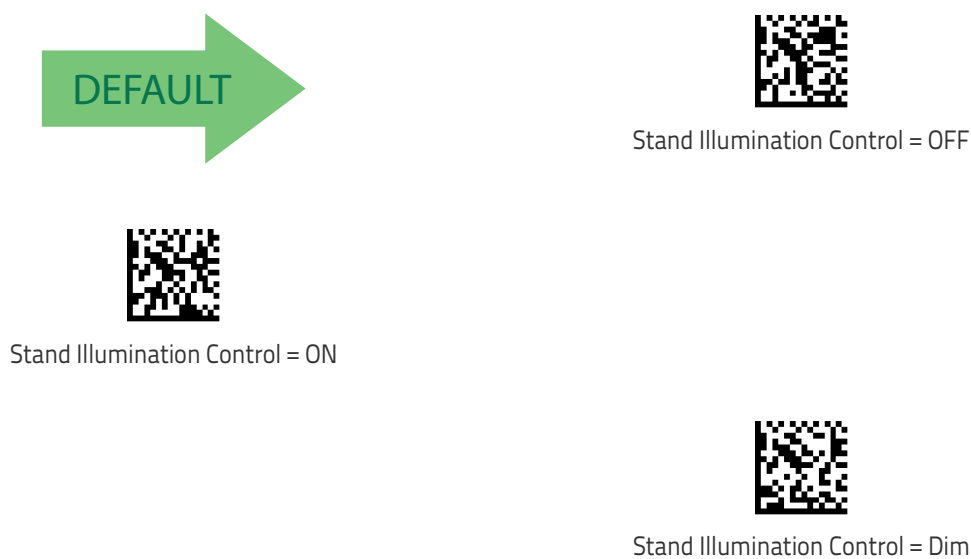



Flash On Time

This feature specifies the ON time for the indicator LED while in Flash Mode. The selectable range is 100 to 9,900 milliseconds (0.1 to 9.9 seconds), in 100 millisecond increments. See [page 283](#) in “References” for detailed information on setting this feature.

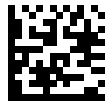

Select Flash ON Time Setting

To configure this feature, scan the ENTER/EXIT PROGRAMMING MODE bar code above, then the bar code at left followed by the digits from the Alphanumeric characters in [Appendix D, Keypad](#) representing your desired character(s). End by scanning the ENTER/EXIT bar code again.

Make a mistake? Scan the CANCEL bar code to abort and not save the entry string. You can then start again at the beginning.

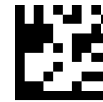

CANCEL

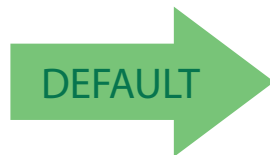

10 = Flash is ON for 1 Second

Flash Off Time

This feature specifies the OFF time for the indicator LED while in Flash Mode. The selectable range is 100 to 9,900 milliseconds (0.1 to 9.9 seconds), in 100 millisecond increments. See [page 284](#) in “References” for detailed information on setting this feature.



Select Flash OFF Time Setting

To configure this feature, scan the ENTER/EXIT PROGRAMMING MODE bar code above, then the bar code at left followed by the digits from the Alphanumeric characters in [Appendix D, Keypad](#) representing your desired character(s). End by scanning the ENTER/EXIT bar code again.

Make a mistake? Scan the CANCEL bar code to abort and not save the entry string. You can then start again at the beginning.



CANCEL

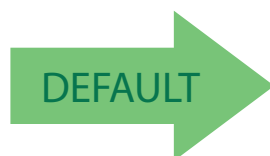

06 = Flash is OFF for 600ms



Enter/Exit Programming Mode

Aiming Pointer

Enables/disables the aiming pointer for all symbologies.



Aiming Pointer = Enable



Aiming Pointer = Disable



Aiming Duration Timer

Specifies the frame of time the aiming pointer remains on after decoding a label, when in trigger single mode. The range for this setting is from 1 to 255 seconds in 1-second increments. See [page 282](#) in “References” for a description of this feature.



Set Aiming Duration Timer



Aiming Off After Decoding

To configure, scan the ENTER/EXIT PROGRAMMING MODE bar code above, then the bar code at left followed by the digits from the Alphanumeric characters in [Appendix D, Keypad](#) representing your desired character(s). End by scanning the ENTER/EXIT bar code.

Make a mistake? Scan the CANCEL bar code to abort and not save the entry string. You can then start again at the beginning.



CANCEL



Green Spot Duration

Specifies the duration of the good read pointer beam after a good read.



Green Spot Duration = Disable (Green Spot is Off)



Green Spot Duration = Short (300 msec)



Green Spot Duration = Medium (500 msec)



Green Spot Duration = Long (800 msec)

Partial Label Reading Control

Enable/Disable the option to ignore partial labels to be read within the boundary of the field of view.



Partial Label Reading Control = Disable



Partial Label Reading Control = Enable



Decode Negative Image

Enable/Disable the ability to decode a negative image for all symbologies. When this feature is enabled, you will be unable to read normally-printed labels or programming labels in this manual. Scan the “Disable” bar code below to return the scanner to its default for this feature.

The reader can also be set to decode both positive and negative codes for certain 2D codes. See “2D Normal/Inverse Symbol Control” on page 175 for information on this feature.

For additional options, see the Aladdin configuration application.



Unlike some programming features and options, Decode Negative Image selections require that you scan only one programming bar code label. **DO NOT** scan an ENTER/EXIT bar code prior to scanning a Decode Negative Image bar code.



CAUTION

When this feature is enabled, you will be unable to read other programming labels in this manual.

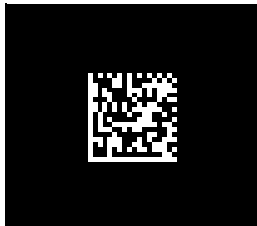

Decode Negative Image = Disable



Decode Negative Image = Enable

Image Capture

Image capture is supported by RS-232 and USB-COM interfaces only. For information and a list of options for Image Capture, use the Datalogic Aladdin configuration application, available for free download from the Datalogic Scanning website.



MULTIPLE LABEL READING

In standard (default) mode, when the reader's aiming system is activated (by a trigger pull, motion or other method depending on the mode), it then acquires and processes each image in the area in front of it (the Volume). In this case, the scanner stops processing the image once it decodes a label. If several labels are present in the volume, only the first label encountered is decoded and sent.

When Multiple Reading Mode is enabled, the scanner keeps on processing the image until all the labels present are decoded. The reader then sorts the data from all the bar codes (if configured to do so) before transmitting it.

Multiple Labels per Frame

Specifies the ability of the reader to decode and transmit a set of code labels in a specific volume and in a single frame of time. When in Multiple Labels per Frame the reader beeps and turns on the good read LED indication for each code read in a frame.

When Multiple Labels Mode is enabled, ISBT pairing, ABC Codabar pairing, and composites are not allowed.

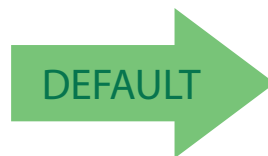

Multiple Labels per Frame = Disable



Multiple Labels per Frame = Enable



Multiple Labels Ordering by Code Symbology

This feature allows you to specify the order multiple labels are transmitted by symbology type, when Multiple Labels per Frame is enabled. See page 285 in “References” for detailed information on setting this feature.



Select Symbologies for Multiple Labels Ordering

To configure this feature, scan the ENTER/EXIT PROGRAMMING MODE bar code above, then the bar code at left followed by the digits From the alphanumeric characters In Appendix d, keypad representing your desired Character(s). end by scanning the enter/exit bar code again.

Make a mistake? Scan the CANCEL bar code to abort and not save the entry string. You can then start again at the beginning.



CANCEL



00000000000 = Random order

Multiple Labels Ordering by Code Length

Specifies the transmission ordering by code length, when Multiple Labels per Frame is enabled.

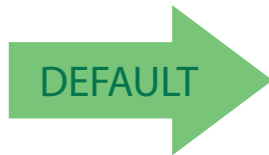

Multiple Labels Ordering = Disable



Transmit Increasing Length Order



Transmit Decreasing Length Order

1D SYMBOLOGIES

The reader supports the following 1D symbologies (bar code types). See "2D Symbologies" starting on page 173 for 2D bar codes. Symbology-dependent options are included in each chapter.

Disable All Symbologies, page 82	GS1-128, page 119
Code EAN/UPC, page 83	Code ISBT 128, page 120
UPC-E, page 86	Interleaved 2 of 5 (I 2 of 5), page 123
GTIN Formatting, page 89	Interleaved 2 of 5 CIP HR, page 128
EAN 13 (Jan 13), page 90	Follett 2 of 5, page 128
ISSN, page 92	Standard 2 of 5, page 129
EAN 8 (Jan 8), page 93	Industrial 2 of 5, page 133
UPC/EAN Global Settings, page 95	Code IATA, page 137
Add-Ons, page 97	Codabar, page 138
Code 39, page 103	ABC Codabar, page 144
Trioptic Code, page 109	Code 11, page 147
Code 32 (Ital Pharmaceutical Code), page 109	GS1 DataBar™ Omnidirectional, page 151
Code 39 CIP (French Pharmaceutical), page 111	GS1 DataBar™ Expanded, page 152
Code 39 Danish PPT, page 111	GS1 DataBar™ Limited, page 157
Code 39 LaPoste, page 112	Code 93, page 158
Code 39 PZN, page 112	MSI, page 163
Code 128, page 113	Plessey, page 168

Default settings are indicated at each feature/option with a green arrow. Also reference [Appendix C, Standard Defaults](#) for a listing of the most widely used set of standard factory settings.

To set most features:

1. Scan the ENTER/EXIT PROGRAMMING bar code at the top of applicable programming pages.
2. Scan the correct bar code to set the desired programming feature or parameter. You may need to cover unused bar codes on the page, and possibly the facing page, to ensure that the reader reads only the bar code you intend to scan.
3. If additional input parameters are needed, go to [Appendix D, Keypad](#), and scan the appropriate characters from the keypad.



Additional information about many features can be found in the "References" chapter.

If you make a mistake before the last character, scan the CANCEL bar code to abort and not save the entry string. You can then start again at the beginning.

4. Complete the programming sequence by scanning the ENTER/EXIT PROGRAMMING bar code to exit Programming Mode.



DISABLE ALL SYMBOLOGIES

Use this feature to disable all symbologies.

1. Scan the ENTER/EXIT PROGRAMMING Mode bar code.
2. Scan the Disable All Symbologies bar code.
3. Complete the programming sequence by scanning the ENTER/EXIT PROGRAMMING bar code.



Disable All Symbologies



This does not disable the reading of programming labels.



CODE EAN/UPC

Coupon Control

This feature is used to control the reader's method of processing coupon labels.



Coupon Control = Allow all coupon bar codes to be decoded



Coupon Control = Enable only UPCA coupon decoding



Coupon Control = Enable only GS1 DataBar™ coupon decoding



UPC-A

The following options apply to the UPC-A symbology.

UPC-A Enable/Disable

When disabled, the reader will not read UPC-A bar codes.



UPC-A = Disable



UPC-A = Enable



UPC-A Check Character Transmission

Enable this option to transmit the check character along with UPC-A bar code data.



UPC-A Check Character Transmission = Don't Send



UPC-A Check Character Transmission = Send





Expand UPC-A to EAN-13

Expands UPC-A data to the EAN-13 data format. Selecting this feature also changes the symbology ID to match those required for EAN-13.

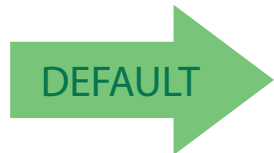

UPC-A to EAN-13 = Don't Expand



UPC-A to EAN-13 = Expand

UPC-A Number System Character Transmission

This feature enables/disables transmission of the UPC-A number system character.



UPC-A Number System Character = Do not transmit



UPC-A Number System Character = Transmit





UPC-A 2D Component

This feature enables/disables a requirement that a 2D label component be decoded when a base label of this symbology is decoded.

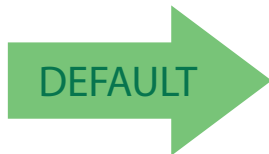

EAN-13 2D Component =
Disable (2D component not required)



EAN-13 2D Component =
2D component must be decoded

UPC-E

The following options apply to the UPC-E symbology.

UPC-E Enable/Disable

When disabled, the reader will not read UPC-E bar codes.



UPC-E = Disable



UPC-E = Enable





UPC-E Check Character Transmission

Enable this option to transmit the check character along with UPC-E bar code data.



UPC-E Check Character Transmission = Don't Send



UPC-E Check Character Transmission = Send

UPC-E 2D Component

This feature enables/disables a requirement that a 2D label component be decoded when a base label for this symbology is decoded.

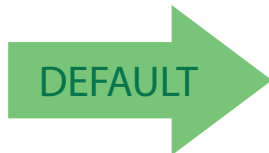

UPC-E 2D Component =
Disable (2D component not required)



UPC-E 2D Component =
2D component must be decoded



Expand UPC-E to EAN-13

Expands UPC-E data to the EAN-13 data format. Selecting this feature also changes the symbology ID to match those required for EAN-13.

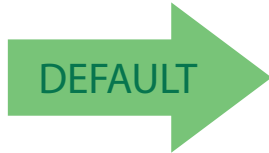

UPC-E to EAN-13 = Don't Expand



UPC-E to EAN-13 = Expand

Expand UPC-E to UPC-A

Expands UPC-E data to the UPC-A data format.

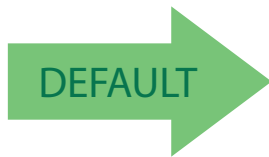

UPC-E to UPC-A = Don't Expand



UPC-E to UPC-A = Expand



UPC-E Number System Character Transmission

This feature enables/disables transmission of the UPC-E system number character.



UPC-E Number System Character = Do not transmit



UPC-E Number System Character = Transmit

GTIN FORMATTING

This feature enables/disables the ability to convert UPC-E, UPC-A, EAN 8, and EAN 13 labels into the GTIN 14-character format.



If add-on information is present on the base label prior to the conversion taking place, the add-on information will be appended to the converted GTIN label.

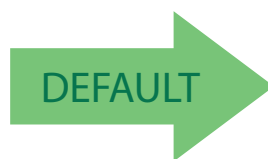

GTIN Formatting = Disable



GTIN Formatting = Enable



EAN 13 (JAN 13)

The following options apply to the EAN 13 (Jan 13) symbology.

EAN 13 Enable/Disable

When disabled, the reader will not read EAN 13/JAN 13 bar codes.



EAN 13 = Enable



EAN 13 = Disable



EAN 13 Check Character Transmission

Enable this option to transmit the check character along with EAN 13 bar code data.



EAN 13 Check Character Transmission = Send



EAN 13 Check Character Transmission = Don't Send





EAN-13 Flag 1 Character

Enables/disables transmission of an EAN/JAN13 Flag1 character. The Flag 1 character is the first character of the label.



EAN-13 Flag 1 Char= Don't transmit



EAN-13 Flag 1 Char= Transmit

EAN-13 ISBN Conversion

This option enables/disables conversion of EAN 13/JAN 13 Bookland labels starting with 978 to ISBN labels.



EAN-13 ISBN Conversion = Disable



EAN-13 ISBN Conversion = Convert to ISBN



EAN-13 2D Component

This feature enables/disables a requirement that a 2D label component be decoded when a base label of this symbology is decoded.

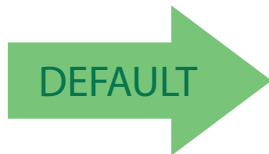

EAN-13 2D Component =
Disable (2D component not required)



EAN-13 2D Component =
2D component must be decoded

ISSN

The following options apply to the ISSN symbology.

ISSN Enable/Disable

Enables/disables conversion of EAN/JAN13 Bookland labels starting with 977 to ISSN labels.

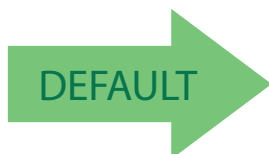

ISSN = Disable



ISSN = Enable



EAN 8 (JAN 8)

The following options apply to the EAN 8 (Jan 8) symbology.

EAN 8 Enable/Disable

When disabled, the reader will not read EAN 8/JAN 8 bar codes.



EAN 8 Check Character Transmission

Enable this option to transmit the check character along with EAN 8 bar code data.

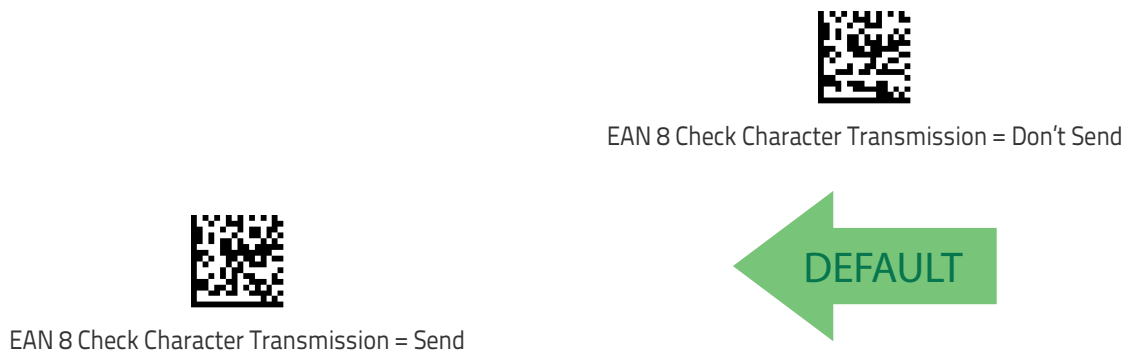



Expand EAN 8 to EAN 13

Enable this option to expand EAN 8/JAN 8 labels to EAN 13/JAN 13.

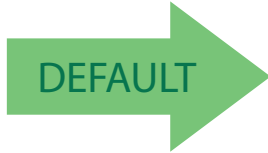

Expand EAN 8 to EAN 13 = Disable



Expand EAN 8 to EAN 13 = Enable

EAN 8 2D Component

This feature enables/disables a requirement that a 2D label component be decoded when a base label for this symbology is decoded.

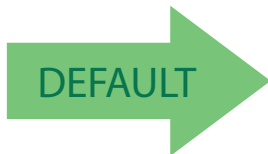

EAN 8 2D Component =
Disable (2D component not required)



EAN 8 2D Component =
2D component must be decoded



UPC/EAN GLOBAL SETTINGS

This section provides configuration settings for UPC-A, UPC-E, EAN 13 and EAN 8 symbologies, and affects all of these unless otherwise marked for each feature description.

UPC/EAN Price Weight Check

This feature enables/disables calculation and verification of price/weight check digits.

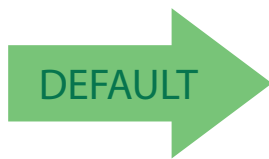

Price Weight Check = Disabled



Price Weight Check = 4-digit price-weight check



Price Weight Check = 5-digit price-weight check



Price Weight Check = European 4-digit price-weight check



Price Weight Check = European 5-digit price-weight check



UPC/EAN Quiet Zones

This feature specifies the number of quiet zones for UPC/EAN labels. Quiet zones are blank areas at the ends of a bar code, typically 10 times the width of the narrowest bar or space in the label. The property applies to all EAN-UPC symbologies globally and to the ADDONs.

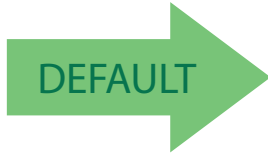

UPC/EAN Quiet Zones = Two Modules



UPC/EAN Quiet Zones = Three Modules



ADD-ONS

Contact Customer Support for advanced programming of optional and conditional add-ons.

Optional Add-ons

The reader can be enabled to optionally read the following add-ons (supplementals):



If a UPC/EAN base label and an add-on are both decoded, the reader will transmit the base label and add-on. If a UPC/EAN base label is decoded without an add-on, the base label will be transmitted without an add-on.

Conditional add-on settings (if enabled) are considered by the reader before optional add-on settings.

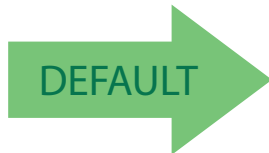

Optional Add-Ons = Disable P2



Optional Add-Ons = Enable P2

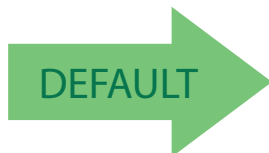

Optional Add-Ons = Disable P5



Optional Add-Ons = Enable P5

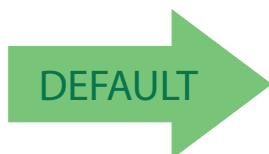

Optional Add-Ons = Disable GS1-128



Optional Add-Ons = Enable GS1-128



Optional Add-On Timer

This option sets the time the reader will look for an add-on when an add-on fragment has been seen and optional add-ons are enabled. (Also see "Optional GS1-128 Add-On Timer" on page 100.)



Optional Add-on Timer = 10ms



Optional Add-on Timer = 20ms



Optional Add-on Timer = 30ms



Optional Add-on Timer = 40ms



Optional Add-on Timer = 50ms



Optional Add-on Timer = 60ms



Optional Add-on Timer = 70ms



Optional Add-on Timer = 100ms



Optional Add-On Timer (continued)



Optional Add-on Timer = 120ms



Optional Add-on Timer = 140ms



Optional Add-on Timer = 160ms



Optional Add-on Timer = 180ms



Optional Add-on Timer = 200ms



Optional Add-on Timer = 220ms



Optional Add-on Timer = 240ms



Optional Add-on Timer = 260ms



Optional Add-On Timer (continued)



Optional Add-on Timer = 280ms



Optional Add-on Timer = 300ms

Optional GS1-128 Add-On Timer

This option sets the timer expiration value to read the added part after reading the linear EAN/UPC part. For UPC/EAN add-ons other than those of that type, see "Optional Add-On Timer" on page 98.

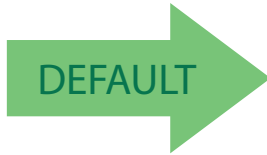

Optional GS1-128 Add-On Timer = Disable



Optional GS1-128 Add-On Timer = 10ms



Optional GS1-128 Add-On Timer = 20ms



Optional GS1-128 Add-On Timer = 30ms



Optional GS1-128 Add-On Timer (continued)



Optional GS1-128 Add-On Timer = 40ms



Optional GS1-128 Add-On Timer = 50ms



Optional GS1-128 Add-On Timer = 60ms



Optional GS1-128 Add-On Timer = 70ms



Optional GS1-128 Add-On Timer = 100ms



Optional GS1-128 Add-On Timer = 120ms



Optional GS1-128 Add-On Timer = 140ms



Optional GS1-128 Add-On Timer = 160ms



Enter/Exit Programming Mode

Optional GS1-128 Add-On Timer (continued)



Optional GS1-128 Add-On Timer = 180ms



Optional GS1-128 Add-On Timer = 200ms



Optional GS1-128 Add-On Timer = 220ms



Optional GS1-128 Add-On Timer = 240ms



Optional GS1-128 Add-On Timer = 260ms



Optional GS1-128 Add-On Timer = 280ms



Optional GS1-128 Add-On Timer = 300ms



CODE 39

The following options apply to the Code 39 symbology.

Code 39 Enable/Disable



Code 39 Check Character Calculation

Enable this option to enables/disables calculation and verification of an optional Code 39 check character. When disabled, any check character in the label is treated as a data character

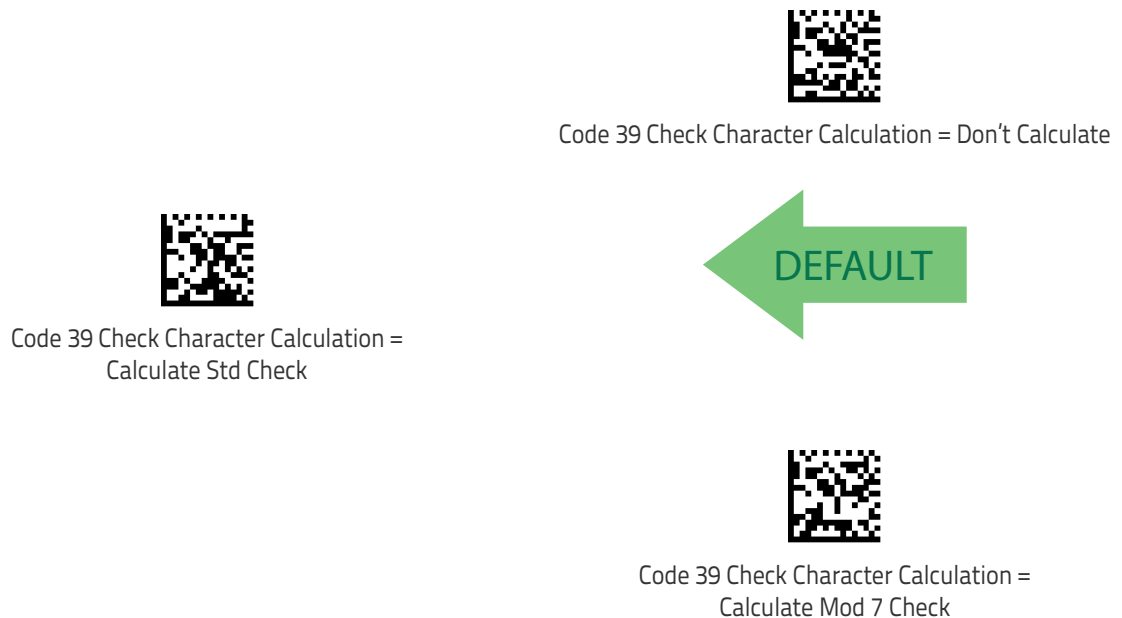



Enter/Exit Programming Mode

Code 39 Check Character Calculation (continued)



Code 39 Check Character Calculation =
Enable Italian Post Check



Code 39 Check Character Calculation =
Enable Daimler Chrysler Check

Code 39 Check Character Transmission

Enable this option to transmit the check character along with Code 39 bar code data.



Code 39 Check Character Transmission = Don't Send



Code 39 Check Character Transmission = Send





Code 39 Start/Stop Character Transmission

Enable this option to enable/disable transmission of Code 39 start and stop characters.

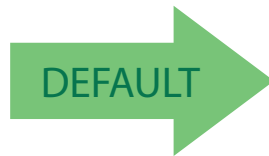

Code 39 Start/Stop Character Transmission =
Don't Transmit



Code 39 Start/Stop Character Transmission = Transmit

Code 39 Full ASCII

Enables/disables the translation of Code 39 characters to Code 39 full-ASCII characters.

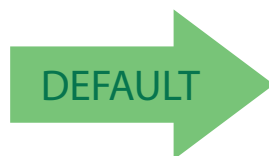

Code 39 Full ASCII = Disable



Code 39 Full ASCII = Enable



Code 39 Quiet Zones

This feature specifies the number of quiet zones for Code 39 labels. Quiet zones are blank areas at the ends of a bar code, typically 10 times the width of the narrowest bar or space in the label.



Code 39 Quiet Zones = Quiet Zones on two sides



Code 39 Quiet Zones = Small Quiet Zones on two sides

Code 39 Length Control

This feature specifies either variable length decoding or fixed length decoding for the Code 39 symbology.

Variable Length: For variable length decoding, a minimum and maximum length may be set.

Fixed Length: For fixed length decoding, two different lengths may be set.

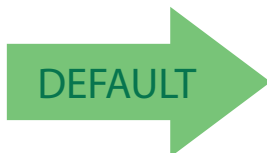

Code 39 Length Control = Variable Length



Code 39 Length Control = Fixed Length



Code 39 Set Length 1

This feature specifies one of the bar code lengths for **Code 39 Length Control**. Length 1 is the minimum label length if in **Variable Length Mode**, or the first fixed length if in **Fixed Length Mode**. Length includes the bar code's data characters only. The length can be set from 0 to 50 characters.

Table 4 provides examples for setting Length 1. See page 267 for detailed instructions on setting this feature.

Table 4. Code 39 Length 1 Setting Examples

STEP	ACTION	EXAMPLES			
1	Desired Setting	00 Characters	07 Characters	15 Characters	50 Characters
2	Scan ENTER/EXIT PROGRAMMING MODE				
3	Scan SELECT CODE 39 LENGTH 1 SETTING				
4	Scan Two Characters From Appendix D, Keypad	'0' and '0'	'0' and '7'	'1' and '5'	'5' AND '0'
5	Scan ENTER/EXIT PROGRAMMING MODE				



Select Code 39 Set Length 1 Setting

Make a mistake? Scan the CANCEL bar code to abort and not save the entry string. You can then start again at the beginning.



CANCEL

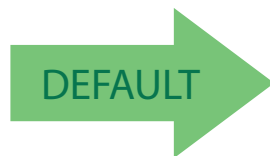

02 = Length 1 is 2 Characters



Code 39 Set Length 2

This feature specifies one of the bar code lengths for Code 39 Length Control. Length 2 is the maximum label length if in Variable Length Mode, or the second fixed length if in Fixed Length Mode. Length includes the bar code's check, data, and full-ASCII shift characters. The length does not include start/stop characters.

Table 5 provides examples for setting Length 2. See page 268 for detailed instructions on setting this feature.

Table 5. Code 39 Length 2 Setting Examples

STEP	ACTION	EXAMPLES			
1	Desired Setting	00 (Ignore This Length)	07 Characters	15 Characters	50 Characters
2	Scan ENTER/EXIT PROGRAMMING MODE				
3	Scan SELECT CODE 39 LENGTH 2 SETTING				
4	Scan Two Characters From Appendix D, Keypad	'0' and '0'	'0' and '7'	'1' and '5'	'5' AND '0'
5	Scan ENTER/EXIT PROGRAMMING .MODE				



Select Code 39 Length 2 Setting

Make a mistake? Scan the CANCEL bar code to abort and not save the entry string. You can then start again at the beginning.



CANCEL



50 = Length 2 is 50 Characters



TRIOPTIC CODE

The following options apply to the Trioptic symbology.

Trioptic Code Enable/Disable

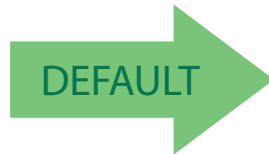

Trioptic Code = Disable



Trioptic Code = Enable

CODE 32 (ITAL PHARMACEUTICAL CODE)

The following options apply to the Code 32 (Italian Pharmaceutical Code) symbology.

Code 32 Enable/Disable

When disabled, the reader will not read Code 32 bar codes.

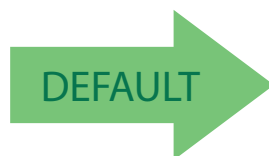

Code 32 = Disable



Code 32 = Enable

Code 32 Feature Setting Exceptions



The following features are set for Code 32 by using these Code 39 settings:

"Code 39 Quiet Zones" on page 106

"Code 39 Length Control" on page 106

"Trioptic Code" on page 109



Code 32 Check Character Transmission

Enable this option to transmit the check character along with Code 32 bar code data.

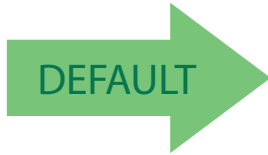

Code 32 Check Character Transmission = Don't Send



Code 32 Check Character Transmission = Send

Code 32 Start/Stop Character Transmission

This option enables/disables transmission of Code 32 start and stop characters.

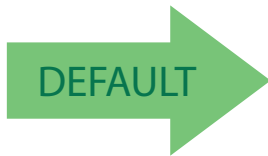

Code 32 Start/Stop Character Transmission =
Don't Transmit



Code 32 Start/Stop Character Transmission = Transmit



CODE 39 CIP (FRENCH PHARMACEUTICAL)

The following options apply to the Code 39 CIP symbology.

Code 39 CIP Enable/Disable

Enables/Disables ability of the reader to decode Code 39 CIP labels.

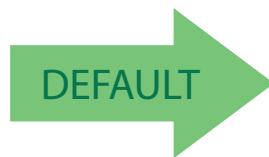

Code 39 CIP = Disable



Code 39 CIP = Enable

CODE 39 DANISH PPT

The following options apply to the Code 39 Danish PPT symbology.

Code 39 Danish PPT Enable/Disable

Enables/Disables AIM ID for Code 39 Danish PPT Codes.

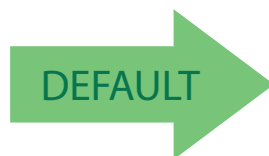

Code 39 Danish PPT = Disable



Code 39 Danish PPT = Enable



CODE 39 LAPOSTE

The following options apply to the Code 39 LaPoste symbology.

Code 39 LaPoste Enable/Disable

Enables/disables the ability of the scanner to decode Code39 La Poste labels.

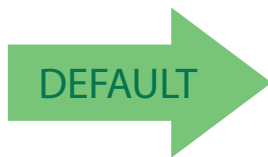

Code 39 LaPoste = Disable



Code 39 LaPoste = Enable

CODE 39 PZN

The following options apply to the Code 39 PZN symbology.

Code 39 PZN Enable/Disable

Enables/disables the ability of the scanner to decode Code39 PZN labels.

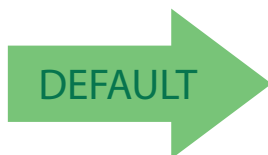

Code 39 PZN = Disable



Code 39 PZN = Enable



CODE 128

The following options apply to the Code 128 symbology.

Code 128 Enable/Disable

When disabled, the reader will not read Code 128 bar codes.



Expand Code 128 to Code 39

This feature enables/disables expansion of Code 128 labels to Code 39 labels.

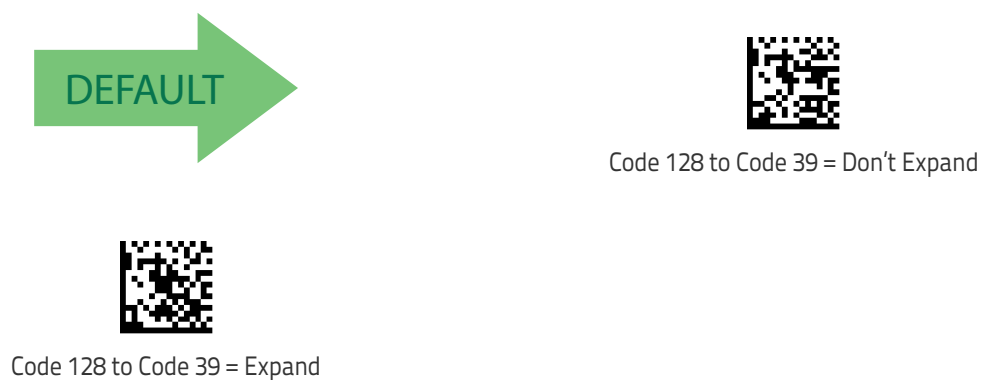



Code 128 Check Character Transmission

Enable this option to transmit the check character along with Code 128 bar code data.

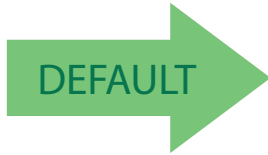

Code 128 Check Character Transmission = Don't Send



Code 128 Check Character Transmission = Send

Code 128 Function Character Transmission

Enables/disables transmission of Code128 function characters 1, 2, 3, and 4.

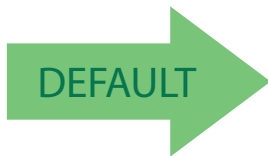

Code 128 Function Character Transmission = Don't Send



Code 128 Function Character Transmission = Send



Code 128 Sub-Code Exchange Transmission

Enables/disables the transmission of “Sub-Code Exchange” characters (NOT transmitted by standard decoding).

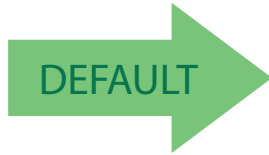

Code 128 Sub-Code Exchange Transmission = Disable



Code 128 Sub-Code Exchange Transmission = Enable

Code 128 Quiet Zones

This feature specifies the number of quiet zones for Code 128 labels. Quiet zones are blank areas at the ends of a bar code and are typically 10 times the width of the narrowest bar or space in the label.



Code 128 Quiet Zones = Quiet Zones on two sides



Code 128 Quiet Zones = Small Quiet Zones on two sides





Code 128 Length Control

This feature specifies either variable length decoding or fixed length decoding for the Code 128 symbology. See [page 267](#) for more information.

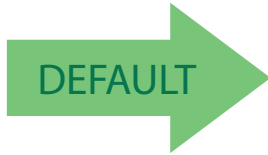

Code 128 Length Control = Variable Length



Code 128 Length Control = Fixed Length



Code 128 Set Length 1

Specifies one of the bar code lengths for Code 128 Length Control. Length 1 is the minimum label length if in Variable Length Mode, or the first fixed length if in Fixed Length Mode. Length includes the bar code's data characters only. The length can be set from 1 to 80 characters.

Table 6 provides some examples for setting Length 1. See page 267 for detailed instructions on setting this feature.

Table 6. Code 128 Length 1 Setting Examples

STEP	ACTION	EXAMPLES			
1	Desired Setting	01 Character	07 Characters	15 Characters	80 Characters
2	Scan ENTER/EXIT PROGRAMMING MODE				
3	Scan SELECT CODE 128 LENGTH 1 SETTING				
4	Scan Two Characters From Appendix D, Keypad	'0' and '1'	'0' and '7'	'1' and '5'	'8' AND '0'
5	Scan ENTER/EXIT PROGRAMMING MODE				



Select Code 128 Set Length 1 Setting

Make a mistake? Scan the CANCEL bar code to abort and not save the entry string. You can then start again at the beginning.



CANCEL

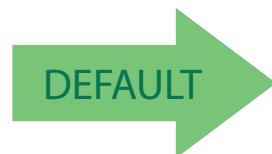

01 = Length 1 is 1 Character



Enter/Exit Programming Mode

Code 128 Set Length 2

This feature specifies one of the bar code lengths for **Code 128 Length Control**. Length 2 is the maximum label length if in **Variable Length Mode**, or the second fixed length if in **Fixed Length Mode**. Length includes the bar code's data characters only.

The length can be set from 1 to 80 characters. A setting of 0 specifies to ignore this length (only one fixed length).

Table 7 provides examples for setting Length 2. See page 268 for detailed instructions on setting this feature.

Table 7. Code 128 Length 2 Setting Examples

STEP	ACTION	EXAMPLES			
1	Desired Setting	00 (Ignore This Length)	07 Characters	15 Characters	80 Characters
2	Scan ENTER/EXIT PROGRAMMING MODE				
3	Scan SELECT CODE 128 LENGTH 2 SETTING				
4	Scan Two Characters From Appendix D, Keypad	'0' and '0'	'0' and '7'	'1' and '5'	'8' and '0'
5	Scan ENTER/EXIT PROGRAMMING MODE				



Select Code 128 Length 2 Setting

Make a mistake? Scan the CANCEL bar code to abort and not save the entry string. You can then start again at the beginning.



CANCEL

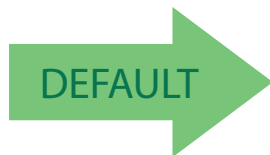

80 = Length 2 is 80 Characters



GS1-128

The following options apply to the GS1-128 symbology. (Also known as USS-128, GS1-128, GTIN-128, UCC-128, EAN-128.)

GS1-128 Enable

This option enables/disables the ability of the reader to translate GS1-128 labels to the GS1-128 data format. Options are:

- Transmit GS1-128 labels in Code 128 data format.
- Transmit GS1-128 labels in GS1-128 data format.
- Do not transmit GS1-128 labels.

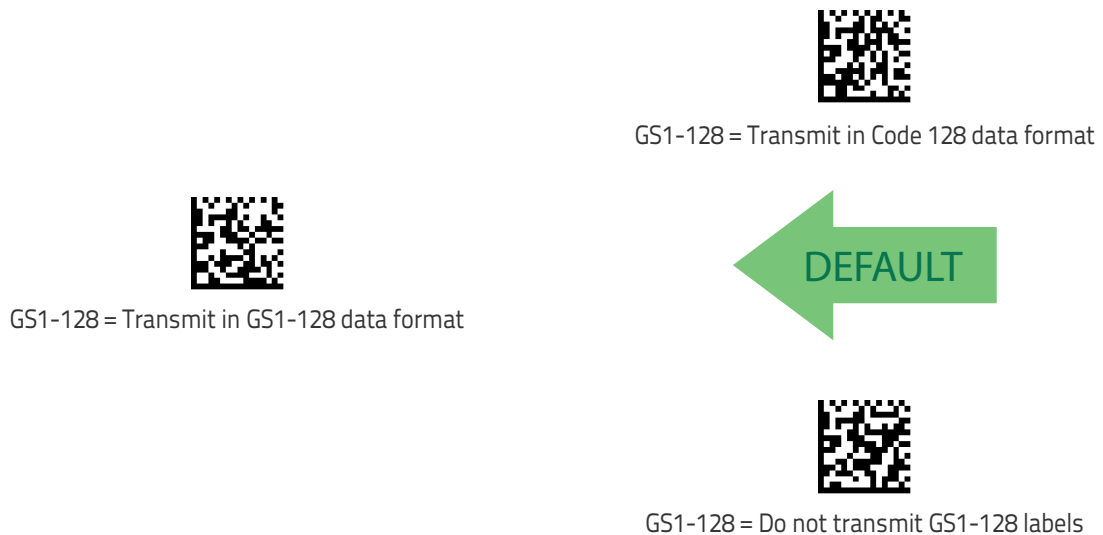

GS1-128 2D Component

This feature enables/disables a requirement that a 2D label component be decoded when a base label of this symbology is decoded.





CODE ISBN 128

The following options apply to the ISBN 128 symbology.

ISBN 128 Concatenation

Use this option to enable/disable ISBN128 concatenation of 2 labels.



ISBN 128 Concatenation = Disable



ISBN 128 Concatenation = Enable

ISBN 128 Force Concatenation

When enabled, this feature forces concatenation for ISBN.



This option is only valid when ISBN 128 Concatenation is enabled.

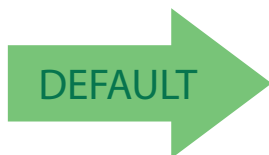

ISBN 128 Force Concatenation = Disable



ISBN 128 Force Concatenation = Enable



ISBT 128 Concatenation Mode

Specifies the concatenation mode between Static and Dynamic.



This option is only valid when ISBT 128 Concatenation is enabled (see "ISBT 128 Concatenation" on page 120).

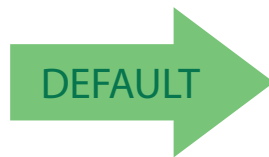

ISBT 128 Concatenation Mode = Static



ISBT 128 Concatenation Mode = Dynamic



ISBT 128 Dynamic Concatenation Timeout

Specifies the timeout used by the ISBT 128 Dynamic Concatenation Mode.



ISBT 128 Dynamic Concatenation Timeout = 50 msec



ISBT 128 Dynamic Concatenation Timeout = 100 msec

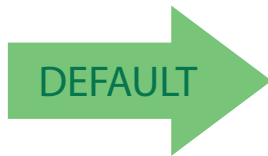

ISBT 128 Dynamic Concatenation Timeout = 200 msec



ISBT 128 Dynamic Concatenation Timeout = 500 msec



ISBT 128 Dynamic Concatenation Timeout = 750 msec



ISBT 128 Dynamic Concatenation Timeout = 1 second

ISBT 128 Advanced Concatenation Options



To set up pairs of label types for concatenation, use the Datalogic Aladdin configuration application or contact Datalogic Technical Support, as described on [page 2](#).



INTERLEAVED 2 OF 5 (I 2 OF 5)

The following options apply to the I 2 of 5 symbology.

I 2 of 5 Enable/Disable

When disabled, the reader will not read I 2 of 5 bar codes.

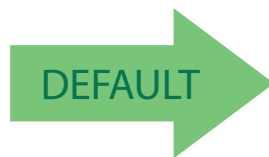

I 2 of 5 = Disable



I 2 of 5 = Enable



I 2 of 5 Check Character Calculation

This option enables/disables calculation and verification of an optional I 2 of 5 check character. Combinations of these settings are possible via the Aladdin configuration utility, or contact Technical Support.

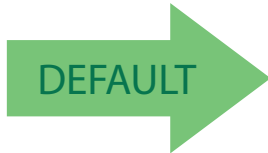

I 2 of 5 Check Character Calculation = Disable



I 2 of 5 Check Character Calculation = Check Standard
(Modulo 10)



I 2 of 5 Check Character Calculation = Check German Parcel



I 2 of 5 Check Character Calculation = Check DHL



I 2 of 5 Check Character Calculation = Check Daimler Chrysler



I 2 of 5 Check Character Calculation = Check Bosch



I 2 of 5 Check Character Calculation = Italian Post



12 of 5 Check Character Transmission

Enable this option to transmit the check character along with 12 of 5 bar code data.



12 of 5 Check Character Transmission = Don't Send



12 of 5 Check Character Transmission = Send

12 of 5 Length Control

This feature specifies either variable length decoding or fixed length decoding for the 12 of 5 symbology.

Variable Length: For variable length decoding, a minimum and maximum length may be set.

Fixed Length: For fixed length decoding, two different lengths may be set.



12 of 5 Length Control = Variable Length



12 of 5 Length Control = Fixed Length



Enter/Exit Programming Mode

I 2 of 5 Set Length 1

This feature specifies one of the bar code lengths for I 2 of 5 Length Control. Length 1 is the minimum label length if in Variable Length Mode, or the first fixed length if in Fixed Length Mode. The length includes the bar code's check and data characters. The length can be set from 2 to 50 characters in increments of two.

Table 8 provides some examples for setting Length 1. See page 267 for detailed instructions on setting this feature.

Table 8. I 2 of 5 Length 1 Setting Examples

STEP	ACTION	EXAMPLES			
1	Desired Setting	2 Characters	6 Characters	14 Characters	50 Characters
2	Pad with leading zeroes to yield two digits	02	06	14	50
3	Scan ENTER/EXIT PROGRAMMING MODE				
4	Scan SELECT I 2 of 5 LENGTH 1 SETTING				
5	Scan Two Characters From Appendix D, Keypad	'0' and '2'	'0' and '6'	'1' and '4'	'5' AND '0'
6	Scan ENTER/EXIT PROGRAMMING MODE				



Select I 2 of 5 Length 1 Setting

Make a mistake? Scan the CANCEL bar code to abort and not save the entry string. You can then start again at the beginning.



CANCEL

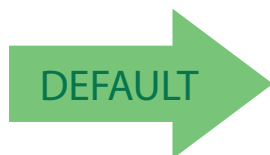

06 = Length 1 is 6 Characters



I 2 of 5 Set Length 2

This feature specifies one of the bar code lengths for I 2 of 5 Length Control. Length 2 is the maximum label length if in Variable Length Mode, or the second fixed length if in Fixed Length Mode. The length includes the bar code's check and data characters.

The length can be set from 2 to 50 characters. A setting of 0 specifies to ignore this length (only one fixed length).

Table 9 provides examples for setting Length 2. See page 268 for detailed instructions on setting this feature.

Table 9. I 2 of 5 Length 2 Setting Examples

STEP	ACTION	EXAMPLES			
1	Desired Setting	Ignore This Length	4 Characters	14 Characters	50 Characters
2	Pad with leading zeroes to yield two digits	00	04	14	50
3	Scan ENTER/EXIT PROGRAMMING MODE				
4	Scan SELECT I 2 OF 5 LENGTH 2 SETTING				
5	Scan Two Characters From Appendix D, Keypad	'0' and '0'	'0' and '4'	'1' and '4'	'5' AND '0'
6	Scan ENTER/EXIT PROGRAMMING MODE				



Select I 2 of 5 Length 2 Setting

Make a mistake? Scan the CANCEL bar code to abort and not save the entry string. You can then start again at the beginning.



CANCEL

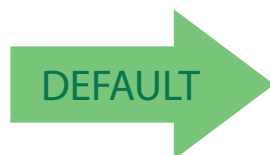

50 = Length 2 is 50 Characters



INTERLEAVED 2 OF 5 CIP HR

The following options apply to the Interleaved 2 of 5 CIP HR symbology.

Interleaved 2 of 5 CIP HR Enable/Disable

Enables/Disables ability of reader to decode Interleaved 2 of 5 CIP HR labels.

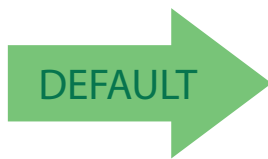

Interleaved 2 of 5 CIP HR = Disable



Interleaved 2 of 5 CIP HR = Enable

FOLLETT 2 OF 5

The following options apply to the Follett 2 of 5 symbology.

Follett 2 of 5 Enable/Disable

Enables/Disables ability of reader to decode Plessey labels.

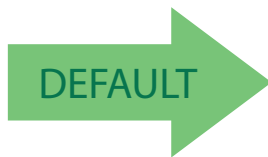

Follett 2 of 5 = Disable



Follett 2 of 5 = Enable



STANDARD 2 OF 5

The following options apply to the Standard 2 of 5 symbology.

Standard 2 of 5 Enable/Disable

When disabled, the reader will not read Standard 2 of 5 bar codes.

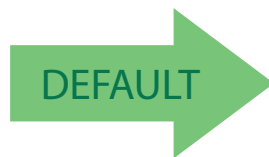

Standard 2 of 5 = Disable



Standard 2 of 5 = Enable

Standard 2 of 5 Check Character Calculation

This option enables/disables calculation and verification of an optional Standard 2 of 5 check character.

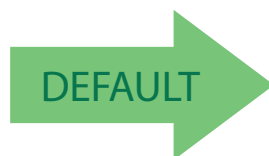

Standard 2 of 5 Check Character Calculation = Disable



Standard 2 of 5 Check Character Calculation = Enable



Standard 2 of 5 Check Character Transmission

This feature enables/disables transmission of an optional Standard 2 of 5 check character.



Standard 2 of 5 Check Character Transmission =
Don't Send



Standard 2 of 5 Check Character Transmission = Send



Standard 2 of 5 Length Control

This feature specifies either variable length decoding or fixed length decoding for the Standard 2 of 5 symbology.

Variable Length: For variable length decoding, a minimum and maximum length may be set.

Fixed Length: For fixed length decoding, two different lengths may be set.

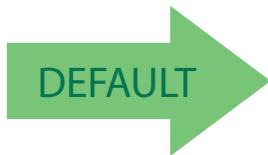

Standard 2 of 5 Length Control = Variable Length



Standard 2 of 5 Length Control = Fixed Length



Standard 2 of 5 Set Length 1

This feature specifies one of the bar code lengths for **Standard 2 of 5 Length Control**. Length 1 is the minimum label length if in **Variable Length Mode**, or the first fixed length if in **Fixed Length Mode**. Length includes the bar code's check and data characters. The length can be set from 1 to 50 characters.

Table 10 provides some examples for setting Length 1. See page 267 if you want detailed instructions on setting this feature.

Table 10. Standard 2 of 5 Length 1 Setting Examples

STEP	ACTION	EXAMPLES			
1	Desired Setting	01 Character	07 Characters	15 Characters	50 Characters
2	Scan ENTER/EXIT PROGRAMMING MODE				
3	Scan SELECT STANDARD 2 OF 5 LENGTH 1 SETTING				
4	Scan Two Characters From Appendix D, Keypad	'0' and '1'	'0' and '7'	'1' and '5'	'5' AND '0'
5	Scan ENTER/EXIT PROGRAMMING MODE				



Select Standard 2 of 5 Length 1 Setting

Make a mistake? Scan the CANCEL bar code to abort and not save the entry string. You can then start again at the beginning.



CANCEL

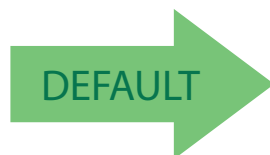

08 = Length 1 is 8 Characters



Standard 2 of 5 Set Length 2

This feature specifies one of the bar code lengths for **Standard 2 of 5 Length Control**. Length 2 is the maximum label length if in **Variable Length Mode**, or the second fixed length if in **Fixed Length Mode**. Length includes the bar code's check and data characters.

The length can be set from 1 to 50 characters. A setting of 0 specifies to ignore this length (only one fixed length).

Table 11 provides examples for setting Length 2. See [page 268](#) for detailed instructions on setting this feature.

Table 11. Standard 2 of 5 Length 2 Setting Examples

STEP	ACTION	EXAMPLES			
1	Desired Setting (pad with leading zeroes)	00 (Ignore This Length)	07 Characters	15 Characters	50 Characters
2	Scan ENTER/EXIT PROGRAMMING MODE				
3	Scan SELECT STANDARD 2 OF 5 LENGTH 2 SETTING				
4	Scan Two Characters From Appendix D, Keypad	'0' and '0'	'0' and '7'	'1' and '5'	'5' AND '0'
5	Scan ENTER/EXIT PROGRAMMING MODE				



Select Standard 2 of 5 Length 2 Setting

Make a mistake? Scan the CANCEL bar code to abort and not save the entry string. You can then start again at the beginning.



CANCEL



50 = Length 2 is 50 Characters



INDUSTRIAL 2 OF 5

The following options apply to the Industrial 2 of 5 symbology.

Industrial 2 of 5 Enable/Disable

Enables/Disables ability of reader to decode Industrial 2 of 5 labels.



Industrial 2 of 5 = Disable



Industrial 2 of 5 = Enable

Industrial 2 of 5 Check Character Calculation

Enables/Disables calculation and verification of an optional Industrial 2 of 5 check character.

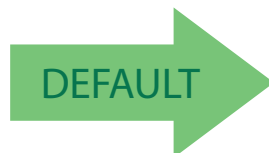

Industrial 2 of 5 Check Character Calculation = Disable



Industrial 2 of 5 Check Character Calculation = Enable



Industrial 2 of 5 Check Character Transmission

Enables/disables transmission of an Industrial 2 of 5 check character.



Industrial 2 of 5 Check Character Transmission = Disable



Industrial 2 of 5 Check Character Transmission = Enable



Industrial 2 of 5 Length Control

This feature specifies either variable length decoding or fixed length decoding for the Industrial 2 of 5 symbology.

Variable Length: For variable length decoding, a minimum and maximum length may be set.

Fixed Length: For fixed length decoding, two different lengths may be set.

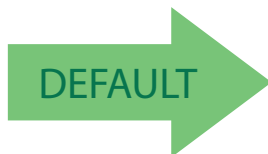

Industrial 2 of 5 Length Control = Variable Length



Industrial 2 of 5 = Fixed Length



Industrial 2 of 5 Set Length 1

This feature specifies one of the bar code lengths for **Industrial 2 of 5 Length Control**. Length 1 is the minimum label length if in **Variable Length Mode**, or the first fixed length if in **Fixed Length Mode**. Length includes the bar code's data characters only. The length can be set from 0 to 50 characters.

Table 12 provides some examples for setting Length 1. See page 267 if you want detailed instructions on setting this feature.

Table 12. Industrial 2 of 5 Length 1 Setting Examples

STEP	ACTION	EXAMPLES			
1	Desired Setting	00 Characters	07 Characters	15 Characters	50 Characters
2	Scan ENTER/EXIT PROGRAMMING MODE				
3	Scan SELECT INDUSTRIAL 2 OF 5 LENGTH 1 SETTING				
4	Scan Two Characters From Appendix D, Keypad	'0' and '0'	'0' and '7'	'1' and '5'	'5' AND '0'
5	Scan ENTER/EXIT PROGRAMMING MODE				



Select Industrial 2 of 5 Set Length 1 Setting

Make a mistake? Scan the CANCEL bar code to abort and not save the entry string. You can then start again at the beginning.



CANCEL

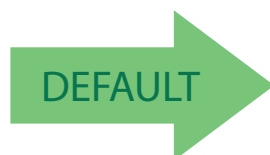

01 = Length 1 is 1 Character



Industrial 2 of 5 Set Length 2

This feature specifies one of the bar code lengths for **Industrial 2 of 5 Length Control**. Length 2 is the maximum label length if in **Variable Length Mode**, or the second fixed length if in **Fixed Length Mode**. Length includes the bar code’s check, data, and full-ASCII shift characters. The length does not include start/stop characters.

The length can be set from 1 to 50 characters. A setting of 0 specifies to ignore this length (only one fixed length).

Table 13 provides examples for setting Length 2. See [page 268](#) for detailed instructions on setting this feature.

Table 13. Industrial 2 of 5 Length 2 Setting Examples

STEP	ACTION	EXAMPLES			
1	Desired Setting	00 (Ignore This Length)	07 Characters	15 Characters	50 Characters
2	Scan ENTER/EXIT PROGRAMMING MODE				
3	Scan SELECT INDUSTRIAL 2 OF 5 LENGTH 2 SETTING				
4	Scan Two Characters From Appendix D, Keypad	'0' and '0'	'0' and '7'	'1' and '5'	'5' AND '0'
5	Scan ENTER/EXIT PROGRAMMING MODE				



Select Industrial 2 of 5 Length 2 Setting

Make a mistake? Scan the CANCEL bar code to abort and not save the entry string. You can then start again at the beginning.



CANCEL

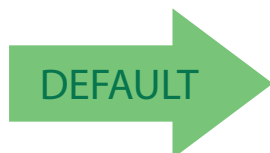

50 = Length 2 is 50 Characters



CODE IATA

The following options apply to the IATA symbology.

IATA Enable/Disable

Enables/Disables the ability of the reader to decode IATA labels.



IATA = Disable



IATA = Enable

IATA Check Character Transmission

Enables/Disables calculation and verification of an optional Industrial 2 of 5 check character.



IATA Check Character Transmission = Disable



IATA Check Character Transmission = Enable





CODABAR

The following options apply to the Codabar symbology.

Codabar Enable/Disable

When disabled, the reader will not read Codabar bar codes.

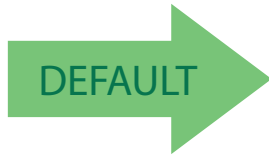

Codabar = Disable



Codabar = Enable

Codabar Check Character Calculation

Enable this option to enables/disables calculation and verification of an optional Codabar check character. When disabled, any check character in the label is treated as a data character

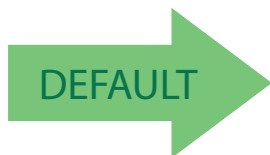

Codabar Check Character Calculation =
Don't Calculate



Codabar Check Character Calculation = Enable AIM standard
check char.



Codabar Check Character Calculation =
Enable Modulo 10 check char.



Codabar Check Character Transmission

Enable this option to transmit the check character along with Codabar bar code data.



Codabar Check Character Transmission = Don't Send



Codabar Check Character Transmission = Send



Codabar Start/Stop Character Transmission

Enable this option to enable/disable transmission of Codabar start and stop characters.



Codabar Start/Stop Character Transmission =
Don't Transmit



Codabar Start/Stop Character Transmission = Transmit





Enter/Exit Programming Mode

Codabar Start/Stop Character Set

This option specifies the format of transmitted Codabar start/stop characters.



Codabar Check Character Set = ABCD/TN*E



Codabar Check Character Set = ABCD/ABCD



Codabar Check Character Set = abcd/tn*e



Codabar Check Character Set = abcd/abcd



Codabar Start/Stop Character Match

When enabled, this option requires that start and stop characters match.

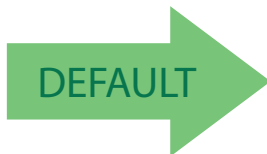

Codabar Start/Stop Character Match =
Don't Require Match



Codabar Start/Stop Character Match = Require Match



Codabar Quiet Zones

Specifies the number of quiet zones for Codabar labels. Quiet zones are blank areas at the ends of a bar code and are typically 10 times the width of the narrowest bar or space in the label.

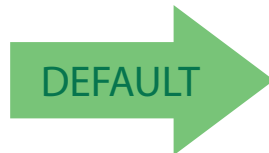

Codabar Quiet Zones = Quiet Zones on two sides



Codabar Quiet Zones = Small Quiet Zones on two sides

Codabar Length Control

This feature specifies either variable length decoding or fixed length decoding for the Codabar symbology.

Variable Length: For variable length decoding, a minimum and maximum length may be set.

Fixed Length: For fixed length decoding, two different lengths may be set.



Codabar Length Control = Variable Length



Codabar Length Control = Fixed Length



Enter/Exit Programming Mode

Codabar Set Length 1

This feature specifies one of the bar code lengths for **Codabar Length Control**. Length 1 is the minimum label length if in **Variable Length Mode**, or the first fixed length if in **Fixed Length Mode**. Length includes the bar code's start, stop, check and data characters. The length must include at least one data character. The length can be set from 3 to 50 characters.

Table 14 provides some examples for setting Length 1. See page 267 for detailed instructions on setting this feature.

Table 14. Codabar Length 1 Setting Examples

STEP	ACTION	EXAMPLES			
1	Desired Setting (and pad with leading zeroes)	03 Characters	09 Characters	15 Characters	50 Characters
2	Scan ENTER/EXIT PROGRAMMING MODE				
3	Scan SELECT CODABAR LENGTH 1 SETTING				
4	Scan Two Characters From Appendix D, Keypad	'0' and '3'	'0' and '9'	'1' and '5'	'5' AND '0'
5	Scan ENTER/EXIT PROGRAMMING MODE				



Select Codabar Length 1 Setting

Make a mistake? Scan the CANCEL bar code to abort and not save the entry string. You can then start again at the beginning.



CANCEL

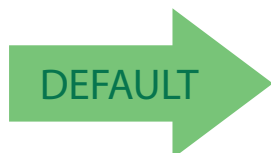

03 = Length 1 is 3 Characters



Codabar Set Length 2

This feature specifies one of the bar code lengths for **Codabar Length Control**. Length 2 is the maximum label length if in **Variable Length Mode**, or the second fixed length if in **Fixed Length Mode**. The length includes the bar code's start, stop, check and data characters. The length must include at least one data character.

The length can be set from 3 to 50 characters. A setting of 0 specifies to ignore this length (only one fixed length).

Table 15 provides examples for setting Length 2. See page 268 for detailed instructions on setting this feature.

Table 15. Codabar Length 2 Setting Examples

STEP	ACTION	EXAMPLES			
1	Desired Setting (and pad with leading zeroes)	00 Ignore This Length	07 Characters	15 Characters	50 Characters
2	Scan ENTER/EXIT PROGRAMMING MODE				
3	Scan SELECT CODABAR LENGTH 2 SETTING				
4	Scan Two Characters From Appendix D, Keypad	'0' and '0'	'0' and '7'	'1' and '5'	'5' AND '0'
5	Scan ENTER/EXIT PROGRAMMING MODE				



Select Codabar Length 2 Setting

Make a mistake? Scan the CANCEL bar code to abort and not save the entry string. You can then start again at the beginning.



CANCEL

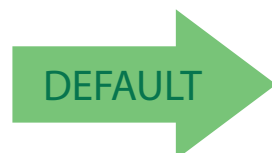

50 = Length 2 is 50 Characters



ABC CODABAR

The following options apply to the ABC Codabar symbology.

ABC Codabar Enable/Disable

Enables/Disables ability of reader to decode ABC Codabar labels.

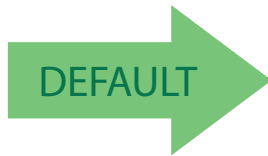

ABC Codabar = Disable



ABC Codabar = Enable

ABC Codabar Concatenation Mode

Specifies the concatenation mode between Static and Dynamic.

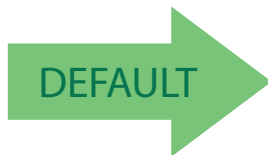

ABC Codabar Concatenation Mode = Static



ABC Codabar Concatenation Mode = Dynamic



ABC Codabar Dynamic Concatenation Timeout

Specifies the timeout in 10-millisecond ticks used by the ABC Codabar Dynamic Concatenation Mode.



ABC Codabar Dynamic Concatenation Timeout =
50 msec



ABC Codabar Dynamic Concatenation Timeout =
100 msec

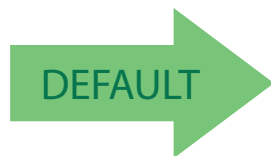

ABC Codabar Dynamic Concatenation Timeout =
200 msec



ABC Codabar Dynamic Concatenation Timeout =
500 msec



ABC Codabar Dynamic Concatenation Timeout =
750 msec



ABC Codabar Dynamic Concatenation Timeout =
1 Second



Enter/Exit Programming Mode

ABC Codabar Force Concatenation

Forces labels starting or ending with D to be concatenated.

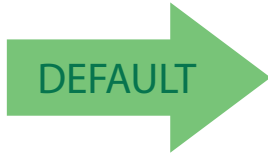

ABC Codabar Force Concatenation = Disable



ABC Codabar Force Concatenation = Enable



CODE 11

The following options apply to the Code 11 symbology.

Code 11 Enable/Disable

When disabled, the reader will not read Code 11 bar codes.



Code 11 = Disable



Code 11 = Enable

Code 11 Check Character Calculation

This option enables/disables calculation and verification of optional Code 11 check character.



Code 11 Check Character Calculation = Disable



Code 11 Check Character Calculation = Check C



Code 11 Check Character Calculation = Check K



Code 11 Check Character Calculation = Check C and K





Code 11 Check Character Transmission

This feature enables/disables transmission of an optional Code 11 check character.



Code 11 Check Character Transmission = Don't Send



Code 11 Check Character Transmission = Send



Code 11 Length Control

This feature specifies either variable length decoding or fixed length decoding for the Code 11 symbology.

Variable Length: For variable length decoding, a minimum and maximum length may be set.

Fixed Length: For fixed length decoding, two different lengths may be set.

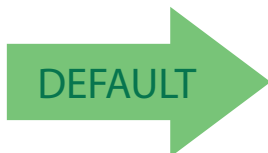

Code 11 Length Control = Variable Length



Code 11 Length Control = Fixed Length



Code 11 Set Length 1

This feature specifies one of the bar code lengths for Code 11 Length Control. Length 1 is the minimum label length if in Variable Length Mode, or the first fixed length if in Fixed Length Mode. Length includes the bar code's check and data characters. The length can be set from 2 to 50 characters.

Table 16 provides some examples for setting Length 1. See page 267 for detailed instructions on setting this feature.

Table 16. Code 11 Length 1 Setting Examples

STEP	ACTION	EXAMPLES			
1	Desired Setting (pad with leading zeroes)	02 Characters	07 Characters	15 Characters	50 Characters
2	Scan ENTER/EXIT PROGRAMMING MODE				
3	Scan SELECT CODE 11 LENGTH 1 SETTING				
4	Scan Two Characters From Appendix D, Keypad	'0' and '2'	'0' and '7'	'1' and '5'	'5' AND '0'
5	Scan ENTER/EXIT PROGRAMMING MODE				



Select Code 11 Set Length 1 Setting

Make a mistake? Scan the CANCEL bar code to abort and not save the entry string. You can then start again at the beginning.



CANCEL

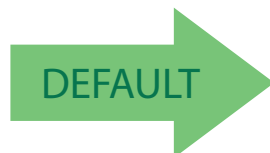

04 = Length 1 is 4 Characters



Enter/Exit Programming Mode

Code 11 Set Length 2

This feature specifies one of the bar code lengths for **Code 11 Length Control**. Length 2 is the maximum label length if in **Variable Length Mode**, or the second fixed length if in **Fixed Length Mode**. Length includes the bar code's check and data characters.

The length can be set from 2 to 50 characters. A setting of 0 specifies to ignore this length (only one fixed length).

Table 17 provides examples for setting Length 2. See [page 268](#) for detailed instructions on setting this feature.

Table 17. Code 11 Length 2 Setting Examples

STEP	ACTION	EXAMPLES			
1	Desired Setting (pad with leading zeroes)	00 (Ignore This Length)	07 Characters	15 Characters	50 Characters
2	Scan ENTER/EXIT PROGRAMMING MODE				
3	Scan SELECT CODE 11 LENGTH 2 SETTING				
4	Scan Two Characters From Appendix D, Keypad	'0' and '0'	'0' and '7'	'1' and '5'	'5' and '0'
5	Scan ENTER/EXIT PROGRAMMING MODE				



Select Code 11 Length 2 Setting

Make a mistake? Scan the CANCEL bar code to abort and not save the entry string. You can then start again at the beginning.



CANCEL





GS1 DATABAR™ OMNIDIRECTIONAL

The following options apply to the GS1 DataBar™ Omnidirectional (formerly RSS-14) symbology.

GS1 DataBar™ Omnidirectional Enable/Disable

When disabled, the reader will not read GS1 DataBar™ Omnidirectional bar codes.

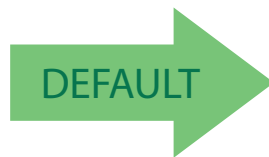

GS1 DataBar™ Omnidirectional = Disable



GS1 DataBar™ Omnidirectional = Enable

GS1 DataBar™ Omnidirectional GS1-128 Emulation

When enabled, GS1 DataBar™ Omnidirectional bar codes will be translated to the GS1-128 label data format.

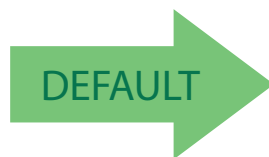

GS1 DataBar™ Omnidirectional GS1-128 Emulation = Disable



GS1 DataBar™ Omnidirectional GS1-128 Emulation = Enable



GS1 DataBar™ Omnidirectional 2D Component

This feature enables/disables a requirement that a 2D label component be decoded when a base label for this symbology is decoded.

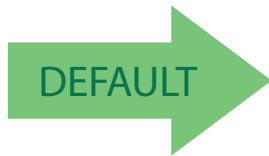

GS1 DataBar™ Omnidirectional 2D Component =
Disable (2D component not required)



GS1 DataBar™ Omnidirectional 2D Component =
2D component must be decoded

GS1 DATABAR™ EXPANDED

The following options apply to the GS1 DataBar™ Expanded (formerly RSS Expanded) symbology.

GS1 DataBar™ Expanded Enable/Disable

When disabled, the reader will not read GS1 DataBar™ Expanded bar codes.

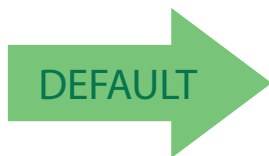

GS1 DataBar™ Expanded = Disable



GS1 DataBar™ Expanded = Enable



GS1 DataBar™ Expanded GS1-128 Emulation

When enabled, GS1 DataBar™ Expanded bar codes will be translated to the GS1-128 label data format.

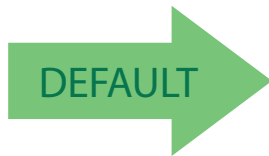

GS1 DataBar™ Expanded GS1-128 Emulation = Disable



GS1 DataBar™ Expanded GS1-128 Emulation = Enable

GS1 DataBar™ Expanded 2D Component

This feature enables/disables a requirement that a 2D label component be decoded when a base label of this symbology is decoded.

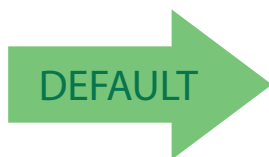

GS1 DataBar™ Expanded 2D Component = Disable



GS1 DataBar™ Expanded 2D Component = Enable



GS1 DataBar™ Expanded Length Control

This feature specifies either variable length decoding or fixed length decoding for the GS1 DataBar™ Expanded symbology.

Variable Length: For variable-length decoding, a minimum length may be set.

Fixed Length: For fixed-length decoding, two different lengths may be set.

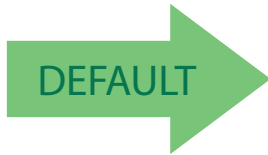

GS1 DataBar™ Expanded Length Control =
Variable Length



GS1 DataBar™ Expanded Length Control = Fixed Length



GS1 DataBar™ Expanded Set Length 1

This feature specifies one of the bar code lengths for GS1 DataBar™ Expanded Length Control. Length 1 is the minimum label length if in Variable Length Mode, or the first fixed length if in Fixed Length Mode. Length includes the bar code’s data characters only. The length can be set from 1 to 74 characters.

Table 18 provides some examples for setting Length 1. See page 267 for detailed instructions on setting this feature.

Table 18. GS1 DataBar™ Expanded Length 1 Setting Examples

STEP	ACTION	EXAMPLES			
1	Desired Setting	01 Character	07 Characters	52 Characters	74 Characters
2	Scan ENTER/EXIT PROGRAMMING MODE				
3	Scan SELECT GS1 DataBar™ EXPANDED LENGTH 1 SETTING				
4	Scan Two Characters From Appendix D, Keypad	'0' and '1'	'0' and '7'	'5' and '2'	'7' AND '4'
5	Scan ENTER/EXIT PROGRAMMING MODE				



Select GS1 DataBar™ Expanded Set Length 1 Setting

Make a mistake? Scan the CANCEL bar code to abort and not save the entry string. You can then start again at the beginning.



CANCEL

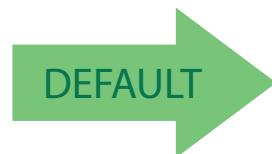

01 = Length 1 is 1 Character



GS1 DataBar™ Expanded Set Length 2

This feature specifies one of the bar code lengths for GS1 DataBar™ Expanded Length Control. Length 2 is the maximum label length if in Variable Length Mode, or the second fixed length if in Fixed Length Mode. Length includes the bar code’s data characters only. The length can be set from 1 to 74 characters. A setting of 0 specifies to ignore this length (only one fixed length).

Table 19 provides examples for setting Length 2. See page 268 for detailed instructions on setting this feature.

Table 19. GS1 DataBar™ Expanded Length 2 Setting Examples

STEP	ACTION	EXAMPLES			
1	Desired Setting	00 (ignore second length)	07 Characters	52 Characters	74 Characters
2	Scan ENTER/EXIT PROGRAMMING MODE				
3	Scan SELECT GS1 DataBar™ EXPANDED LENGTH 2 SETTING				
4	Scan Two Characters From Appendix D, Keypad	'0' and '0'	'0' and '7'	'5' and '2'	'7' and '4'
5	Scan ENTER/EXIT PROGRAMMING MODE				



Select GS1 DataBar™ Expanded Set Length 2 Setting

Make a mistake? Scan the CANCEL bar code to abort and not save the entry string. You can then start again at the beginning.



CANCEL



74 = Length 2 is 74 Characters



GS1 DATABAR™ LIMITED

The following options apply to the GS1 DataBar™ Limited (formerly RSS Limited) symbology.

GS1 DataBar™ Limited Enable/Disable

When disabled, the reader will not read GS1 DataBar™ Limited bar codes.

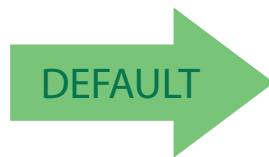

GS1 DataBar™ Limited = Disable



GS1 DataBar™ Limited = Enable

GS1 DataBar™ Limited GS1-128 Emulation

When enabled, GS1 DataBar™ Limited bar codes will be translated to the GS1-128 label data format.

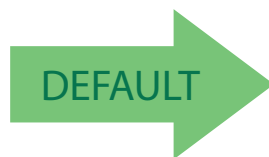

GS1 DataBar™ Limited GS1-128 Emulation = Disable



GS1 DataBar™ Limited GS1-128 Emulation = Enable



GS1 DataBar™ Limited 2D Component

This feature enables/disables a requirement that a 2D label component be decoded when a base label of this symbology is decoded.

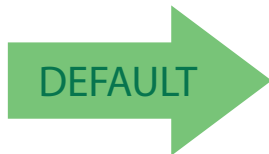

GS1 DataBar™ Limited 2D Component =
Disable (2D component not required)



GS1 DataBar™ Limited 2D Component =
2D component must be decoded

CODE 93

The following options apply to the Code 93 symbology.

Code 93 Enable/Disable

Enables/Disables ability of reader to decode Code 93 labels.



Code 93 = Disable



Code 93 = Enable



Code 93 Check Character Calculation

Enables/disables calculation and verification of an optional Code 93 check character.



Code 93 Check Character Calculation = Disable



Code 93 Check Character Calculation = Enable Check C



Code 93 Check Character Calculation = Enable Check K



Code 93 Check Character Calculation =
Enable Check C and K



Code 93 Check Character Transmission

Enables/disables transmission of an optional Code 93 check character.



Code 93 Check Character Transmission = Disable



Code 93 Check Character Transmission = Enable





Code 93 Length Control

This feature specifies either variable length decoding or fixed length decoding for the Code 93 symbology.

Variable Length: For variable length decoding, a minimum and maximum length may be set.

Fixed Length: For fixed length decoding, two different lengths may be set.

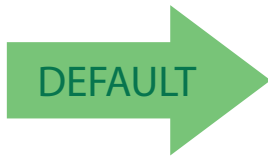

Code 93 Length Control = Variable Length



Code 93 = Fixed Length



Code 93 Set Length 1

Specifies one of the bar code lengths for **Code 93 Length Control**. Length 1 is the minimum label length if in **Variable Length Mode**, or the first fixed length if in **Fixed Length Mode**. Length includes the bar code's data characters only. The length can be set from 01 to 50 characters.

Table 20 provides some examples for setting Length 1. See page 267 for detailed instructions on setting this feature.

Table 20. Code 93 Length 1 Setting Examples

STEP	ACTION	EXAMPLES			
1	Desired Setting	01 Characters	07 Characters	15 Characters	50 Characters
2	Scan ENTER/EXIT PROGRAMMING MODE				
3	Scan SELECT CODE 93 LENGTH 1 SETTING				
4	Scan Two Characters From Appendix D, Keypad	'0' and '1'	'0' and '7'	'1' and '5'	'5' AND '0'
5	Scan ENTER/EXIT PROGRAMMING MODE				



Select Code 93 Set Length 1 Setting

Make a mistake? Scan the CANCEL bar code to abort and not save the entry string. You can then start again at the beginning.



CANCEL

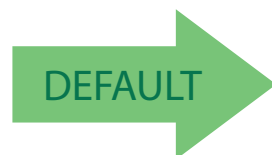

01 = Length 1 is 1 Character



Code 93 Set Length 2

This feature specifies one of the bar code lengths for Code 93 Length Control. Length 2 is the maximum label length if in Variable Length Mode, or the second fixed length if in Fixed Length Mode. Length includes the bar code's check, data, and full-ASCII shift characters. The length does not include start/stop characters. The length can be set from 1 to 50 characters. A setting of 0 specifies to ignore this length (only one fixed length).

Table 21 provides examples for setting Length 2. See page 268 for detailed instructions on setting this feature.

Table 21. CODE 93 Length 2 Setting Examples

STEP	ACTION	EXAMPLES			
1	Desired Setting	00 (Ignore This Length)	07 Characters	15 Characters	50 Characters
2	Scan ENTER/EXIT PROGRAMMING MODE				
3	Scan SELECT CODE 93 LENGTH 2 SETTING				
4	Scan Two Characters From Appendix D, Keypad	'0' and '0'	'0' and '7'	'1' and '5'	'5' AND '0'
5	Scan ENTER/EXIT PROGRAMMING MODE				



Select Code 93 Length 2 Setting

Make a mistake? Scan the CANCEL bar code to abort and not save the entry string. You can then start again at the beginning.



CANCEL





Code 93 Quiet Zones

Enables/disables quiet zones for Code 93.



Code 93 Quiet Zones = Quiet Zones on two sides



Code 93 Quiet Zones = Small Quiet Zones on two sides

MSI

The following options apply to the MSI symbology.

MSI Enable/Disable

Enables/Disables ability of reader to decode MSI labels.

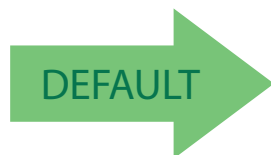

MSI = Disable



MSI = Enable



MSI Check Character Calculation

Enables/Disables calculation and verification of an optional MSI check character.

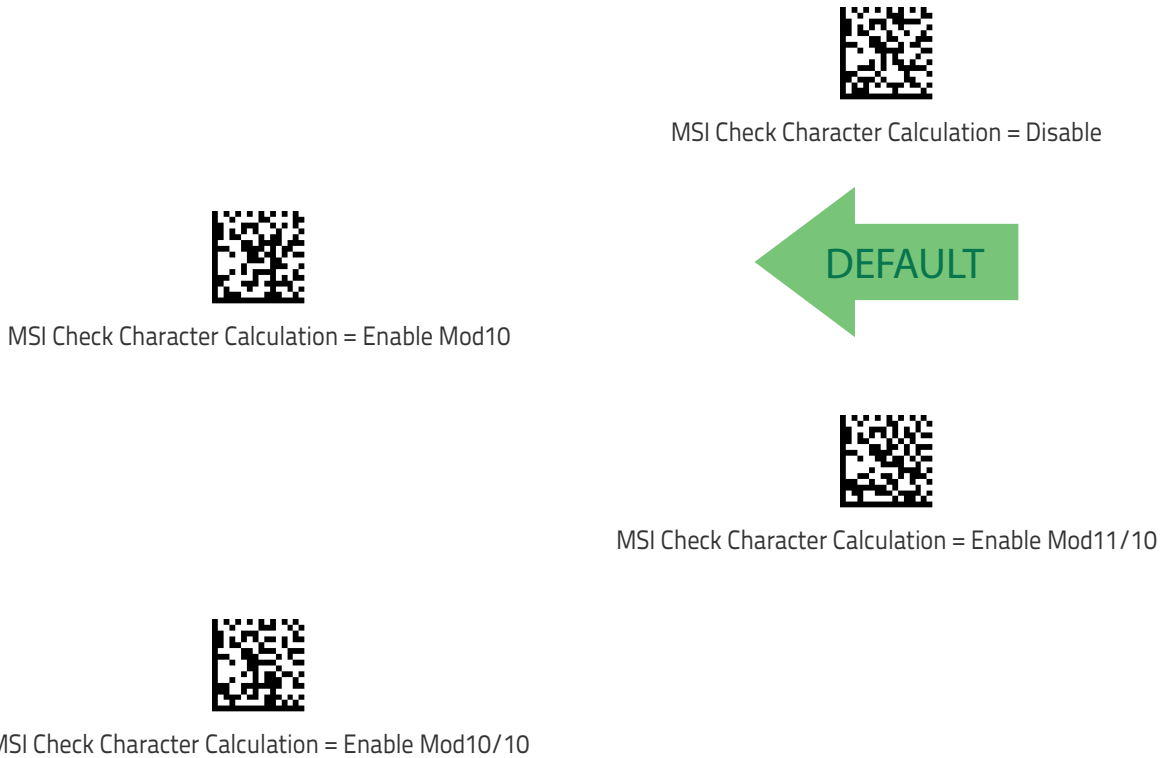

MSI Check Character Transmission

Enables/disables transmission of an MSI check character.

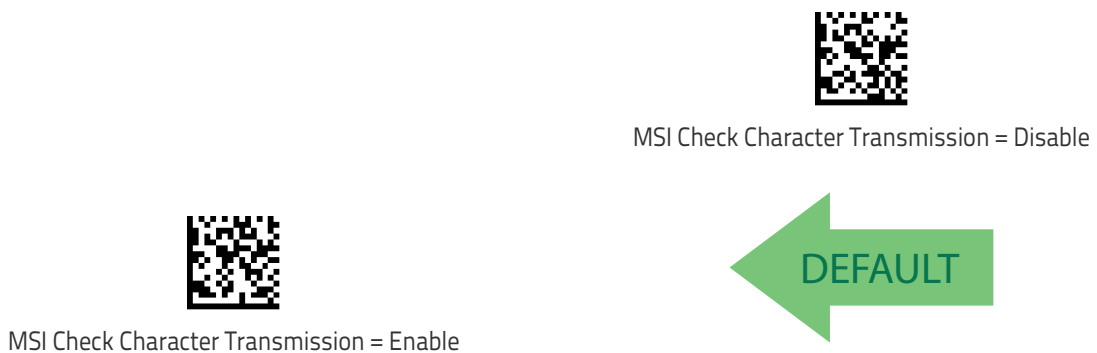



MSI Length Control

This feature specifies either variable length decoding or fixed length decoding for the MSI symbology.

Variable Length: For variable length decoding, a minimum and maximum length may be set.

Fixed Length: For fixed length decoding, two different lengths may be set.

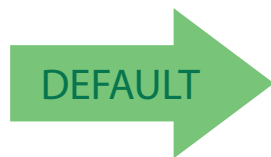

MSI Length Control = Variable Length



MSI = Fixed Length



Enter/Exit Programming Mode

MSI Set Length 1

This feature specifies one of the bar code lengths for **MSI Length Control**. Length 1 is the minimum label length if in **Variable Length Mode**, or the first fixed length if in **Fixed Length Mode**. Length includes the bar code's data characters only. The length can be set from 01 to 50 characters.

Table 22 provides some examples for setting Length 1. See page 267 for detailed instructions on setting this feature.

Table 22. MSI Length 1 Setting Examples

STEP	ACTION	EXAMPLES			
1	Desired Setting	01 Characters	07 Characters	15 Characters	50 Characters
2	Scan ENTER/EXIT PROGRAMMING MODE				
3	Scan SELECT MSI LENGTH 1 SETTING				
4	Scan Two Characters From Appendix D, Keypad	'0' and '1'	'0' and '7'	'1' and '5'	'5' AND '0'
5	Scan ENTER/EXIT PROGRAMMING MODE				



Select MSI Set Length 1 Setting

Make a mistake? Scan the CANCEL bar code to abort and not save the entry string. You can then start again at the beginning.



CANCEL



01 = Length 1 is 1 Character



MSI Set Length 2

This feature specifies one of the bar code lengths for **MSI Length Control**. Length 2 is the maximum label length if in **Variable Length Mode**, or the second fixed length if in **Fixed Length Mode**. Length includes the bar code's check, data, and full-ASCII shift characters. The length does not include start/stop characters.

The length can be set from 1 to 50 characters. A setting of 0 specifies to ignore this length (only one fixed length).

Table 23 provides examples for setting Length 2. See page 268 for detailed instructions on setting this feature.

Table 23. MSI Length 2 Setting Examples

STEP	ACTION	EXAMPLES			
1	Desired Setting	00 (Ignore This Length)	07 Characters	15 Characters	50 Characters
2	Scan ENTER/EXIT PROGRAMMING MODE				
3	Scan SELECT MSI LENGTH 2 SETTING				
4	Scan Two Characters From Appendix D, Keypad	'0' and '0'	'0' and '7'	'1' and '5'	'5' AND '0'
5	Scan ENTER/EXIT PROGRAMMING MODE				



Select MSI Length 2 Setting

Make a mistake? Scan the CANCEL bar code to abort and not save the entry string. You can then start again at the beginning.



CANCEL

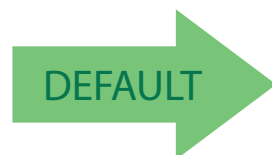

50 = Length 2 is 50 Characters



PLESSEY

The following options apply to the Plessey symbology.

Plessey Enable/Disable

Enables/Disables ability of reader to decode Plessey labels.



Plessey = Disable



Plessey = Enable

Plessey Check Character Calculation

Enables/Disables calculation and verification of an optional Plessey check character.



Plessey Check Character Calculation = Disable



Plessey Check Character Calculation =
Enable Plessey std. check char. verification



Plessey Check Character Calculation =
Enable Anker check char. verification



Plessey Check Character Calculation =
Enable Plessey std. and Anker check char verification



Plessey Check Character Transmission

Enables/disables transmission of an MSI check character.



Plessey Check Character Transmission = Disable



Plessey Check Character Transmission = Enable

Plessey Length Control

This feature specifies either variable length decoding or fixed length decoding for the Plessey symbology.

Variable Length: For variable length decoding, a minimum and maximum length may be set.

Fixed Length: For fixed length decoding, two different lengths may be set.

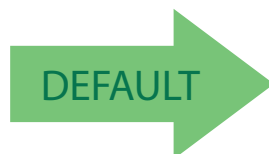

Plessey Length Control = Variable Length



Plessey = Fixed Length



Plessey Set Length 1

This feature specifies one of the bar code lengths for Plessey Length Control. Length 1 is the minimum label length if in Variable Length Mode, or the first fixed length if in Fixed Length Mode. Length includes the bar code's data characters only. The length can be set from 01 to 50 characters.

Table 24 provides some examples for setting Length 1. See page 267 for detailed instructions on setting this feature.

Table 24. Plessey Length 1 Setting Examples

STEP	ACTION	EXAMPLES			
1	Desired Setting	01 Characters	07 Characters	15 Characters	50 Characters
2	Scan ENTER/EXIT PROGRAMMING MODE				
3	Scan SELECT Plessey LENGTH 1 SETTING				
4	Scan Two Characters From Appendix D, Keypad	'0' and '1'	'0' and '7'	'1' and '5'	'5' AND '0'
5	Scan ENTER/EXIT PROGRAMMING MODE				



Select Plessey Set Length 1 Setting

Make a mistake? Scan the CANCEL bar code to abort and not save the entry string. You can then start again at the beginning.



CANCEL



01 = Length 1 is 1 Character



Plessey Set Length 2

This feature specifies one of the bar code lengths for **Plessey Length Control**. Length 2 is the maximum label length if in **Variable Length Mode**, or the second fixed length if in **Fixed Length Mode**. Length includes the bar code's check, data, and full-ASCII shift characters. The length does not include start/stop characters.

The length can be set from 1 to 50 characters. A setting of 0 specifies to ignore this length (only one fixed length).

Table 25 provides examples for setting Length 2. See page 268 for detailed instructions on setting this feature.

Table 25. Plessey Length 2 Setting Examples

STEP	ACTION	EXAMPLES			
1	Desired Setting	00 (Ignore This Length)	07 Characters	15 Characters	50 Characters
2	Scan ENTER/EXIT PROGRAMMING MODE				
3	Scan SELECT PLESSEY LENGTH 2 SETTING				
4	Scan Two Characters From Appendix D, Keypad	'0' and '0'	'0' and '7'	'1' and '5'	'5' AND '0'
5	Scan ENTER/EXIT PROGRAMMING MODE				



Select Plessey Length 2 Setting

Make a mistake? Scan the CANCEL bar code to abort and not save the entry string. You can then start again at the beginning.



CANCEL

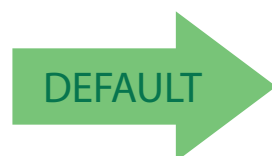

50 = Length 2 is 50 Characters

NOTES

2D SYMBOLOGIES

2D Global Features	
2D Maximum Decoding Time on page 174	2D Normal/Inverse Symbol Control on page 175
2D Structured Append on page 175	

The reader supports the following 2D symbologies (bar code types). Symbology-dependent options for each symbology are included in this chapter. See "1D Symbologies" starting on page 81 for configuration of 1D bar codes.

Aztec Code on page 176	Micro PDF417 on page 192
China Sensible Code on page 179	QR Code on page 195
Data Matrix on page 182	Micro QR Code on page 197
Maxicode on page 186	UCC Composite on page 200
PDF417 on page 189	Postal Code Selection on page 202

2D Global Features

The following features are common to all, or in some cases, most of the available 2D symbologies. Default settings are indicated at each feature/option with a green arrow. Also reference [Appendix C, Standard Defaults](#) for a listing of the most widely used set of standard factory settings. That section also provides space to record any custom settings needed or implemented for your system.

To set most features:

1. Scan the ENTER/EXIT PROGRAMMING bar code at the top of applicable programming pages.
2. Scan the correct bar code to set the desired programming feature or parameter. You may need to cover unused bar codes on the page, and possibly the facing page, to ensure that the reader reads only the bar code you intend to scan.
3. If additional input parameters are needed, go to [Appendix D, Keypad](#), and scan the appropriate characters from the keypad.



Additional information about many features can be found in the "References" chapter.

If you make a mistake before the last character, scan the CANCEL bar code to abort and not save the entry string. You can then start again at the beginning.

Complete the programming sequence by scanning the ENTER/EXIT PROGRAMMING bar code to exit Programming Mode.



2D Maximum Decoding Time

This feature specifies the maximum amount of time the software will spend attempting to decode a 2D label. The selectable range is 10 milliseconds to 2.55 milliseconds.



2D Maximum Decoding Time = 100 msec



2D Maximum Decoding Time = 200 msec



2D Maximum Decoding Time = 350 msec



2D Maximum Decoding Time = 500 msec



2D Maximum Decoding Time = 1 Second



2D Maximum Decoding Time = 2 Seconds



2D Maximum Decoding Time = 2.55 Seconds



2D Structured Append

Enables/disables ability of reader to append multiple 2D Codes labels in a structured format. The structured append property is globally applied to the following symbologies, if these are enabled:

- Data Matrix
- Aztec
- QR Code
- PDF 417

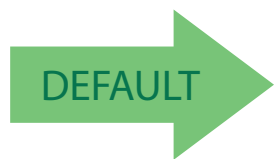

Structured Append = Disable



Structured Append = Enable

2D Normal/Inverse Symbol Control

Specifies the options available for decoding normal/negative printed 2D symbols. This configuration item applies globally to all the 2D symbologies that support that feature according to Standard AIM Specification: Data Matrix, QR, MicroQR, Aztec and Chinese Sensible Code.

To decode all symbologies, including linear symbologies, refer to "[Decode Negative Image](#)" on page 78D Symbology Selection



Normal/Inverse Symbol Control = Normal



Normal/Inverse Symbol Control = Inverse

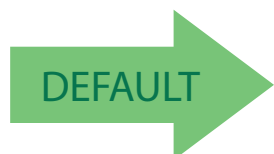

Normal/Inverse Symbol Control =
Both Normal and Inverse



AZTEC CODE

Aztec Code Enable / Disable

Enables/disables the ability of the reader to decode Aztec Code labels.

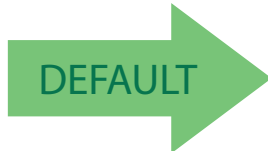

Aztec Code = Disable



Aztec Code = Enable

Aztec Code Length Control

This feature specifies either variable length decoding or fixed length decoding for this symbology.

Variable Length: For variable length decoding, a minimum and maximum length may be set.

Fixed Length: For fixed length decoding, two different lengths may be set.

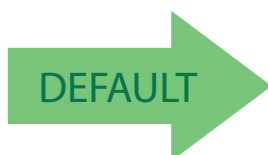

Aztec Code Length Control = Variable Length



Aztec Code Length Control = Fixed Length



Aztec Code Set Length 1

Specifies one of the bar code lengths for **Aztec Code Length Control**. Length 1 is the minimum label length if in **Variable Length Mode**, or the first fixed length if in **Fixed Length Mode**. Characters can be set from 0001 to 3,832 characters in increments of 0001 (pad with zeroes).

See [page 267](#) for detailed instructions on setting this feature.



Select Aztec Code Length 1 Setting

To configure this feature, scan the ENTER/EXIT PROGRAMMING MODE bar code above, then the bar code at left followed by the digits from the Alphanumeric characters in [Appendix D, Keypad](#) representing your desired character(s). End by scanning the ENTER/EXIT bar code again.

Make a mistake? Scan the CANCEL bar code to abort and not save the entry string. You can then start again at the beginning.



CANCEL

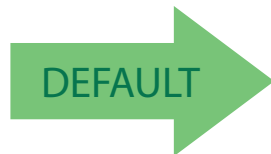

0001 = Length 1 is 1 Character



Aztec Code Set Length 2

This feature specifies one of the bar code lengths for **Aztec Code Length Control**. Length 2 is the maximum label length if in Variable Length Mode, or the second fixed length if in Fixed Length Mode. Characters can be set from 0001 to 3,832 characters in increments of 0001 (pad with zeroes).

See [page 268](#) for detailed instructions on setting this feature.



Select Aztec Code Length 2 Setting

To configure this feature, scan the ENTER/EXIT PROGRAMMING MODE bar code above, then the bar code at left followed by the digits from the Alphanumeric characters in [Appendix D, Keypad](#) representing your desired character(s). End by scanning the ENTER/EXIT bar code again.

Make a mistake? Scan the CANCEL bar code to abort and not save the entry string. You can then start again at the beginning.



CANCEL



Length 2 is 3,832 Characters



CHINA SENSIBLE CODE

China Sensible Code Enable / Disable

Enables/disables the ability of the reader to decode China Sensible Code labels.



China Sensible Code = Disable



China Sensible Code = Enable

China Sensible Code Length Control

This feature specifies either variable length decoding or fixed length decoding for this symbology.

Variable Length: For variable length decoding, a minimum and maximum length may be set.

Fixed Length: For fixed length decoding, two different lengths may be set.

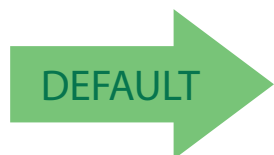

China Sensible Code Length Control = Variable Length



China Sensible Code Length Control = Fixed Length



China Sensible Code Set Length 1

Specifies one of the bar code lengths for **China Sensible Code Length Control**. Length 1 is the minimum label length if in **Variable Length Mode**, or the first fixed length if in **Fixed Length Mode**. Characters can be set from 0001 to 7,827 characters in increments of 0001 (pad with zeroes).

See [page 267](#) for detailed instructions on setting this feature.



Select China Sensible Code Length 1 Setting

To configure this feature, scan the ENTER/EXIT PROGRAMMING MODE bar code above, then the bar code at left followed by the digits from the Alphanumeric characters in **Appendix D, Keypad** representing your desired character(s). End by scanning the ENTER/EXIT bar code again.

Make a mistake? Scan the CANCEL bar code to abort and not save the entry string. You can then start again at the beginning.



CANCEL



0001 = Length 1 is 1 Character



China Sensible Code Set Length 2

This feature specifies one of the bar code lengths for [China Sensible Code Length Control](#). Length 2 is the maximum label length if in Variable Length Mode, or the second fixed length if in Fixed Length Mode. Characters can be set from 0001 to 7,827 characters in increments of 0001 (pad with zeroes).

See [page 268](#) for detailed instructions on setting this feature.



Select China Sensible Code Length 2 Setting

To configure this feature, scan the ENTER/EXIT PROGRAMMING MODE bar code above, then the bar code at left followed by the digits from the Alphanumeric characters in [Appendix D, Keypad](#) representing your desired character(s). End by scanning the ENTER/EXIT bar code again.

Make a mistake? Scan the CANCEL bar code to abort and not save the entry string. You can then start again at the beginning.



CANCEL

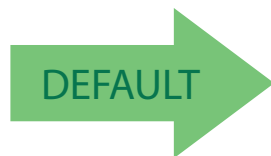

Length 2 is 7,827 Characters



DATA MATRIX

Data Matrix Enable / Disable

Enables/disables ability of reader to decode Data Matrix labels.



Data Matrix = Disable



Data Matrix = Enable

Data Matrix Square/Rectangular Style

Specifies the options available when reading Data Matrix with different form factors. Choices are:

- Square Style
- Rectangular Style
- Both Square and Rectangular Style

The configuration item can also be configured as a bit mask to filter one or more Data Matrix labels with different symbol size AND shape styles.



Data Matrix Dimensions Mask = Square Style



Data Matrix Dimensions Mask = Rectangular Style

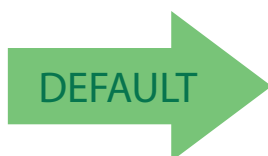

Data Matrix Dimensions Mask = Both Square and Rectangular Style



Data Matrix DPM Decoding Safety

This feature defines the tolerance of DPM decoding software to operate with poor quality labels. Decoding Safety is used to configure a barcode symbology decoder to be very aggressive to very conservative depending on a particular customer's needs. Higher tolerance to poor quality labels increases the reading capability of the scanner.

See [page 267](#) for more information on this feature.



This feature is valid for the PD9530-DPM model only.

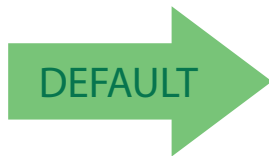

Data Matrix Decoding Safety = 1 (Aggressive)



Data Matrix Decoding Safety = 2



Data Matrix Decoding Safety = 3



Data Matrix Decoding Safety = 4



Data Matrix Decoding Safety = 5 (Conservative)



Data Matrix Length Control

This feature specifies either variable length decoding or fixed length decoding for this symbology.

Variable Length: For variable length decoding, a minimum and maximum length may be set.

Fixed Length: For fixed length decoding, two different lengths may be set.

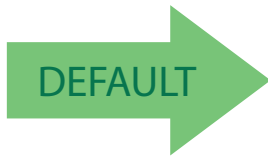

Data Matrix Length Control = Variable Length



Data Matrix Length Control = Fixed Length

Data Matrix Set Length 1

Specifies one of the bar code lengths for **Data Matrix Length Control**. Length 1 is the minimum label length if in **Variable Length Mode**, or the first fixed length if in **Fixed Length Mode**. Characters can be set from 0001 to 3,116 characters in increments of 0001 (pad with zeroes).

See [page 267](#) for detailed instructions on setting this feature.



Select Data Matrix Length 1 Setting

To configure this feature, scan the ENTER/EXIT PROGRAMMING MODE bar code above, then the bar code at left followed by the digits from the Alphanumeric characters in [Appendix D, Keypad](#) representing your desired character(s). End by scanning the ENTER/EXIT bar code again.

Make a mistake? Scan the CANCEL bar code to abort and not save the entry string. You can then start again at the beginning.



CANCEL

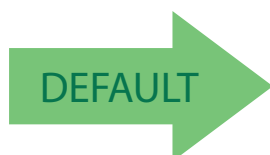

0001 = Length 1 is 1 Character



Data Matrix Set Length 2

This feature specifies one of the bar code lengths for **Data Matrix Length Control**. Length 2 is the maximum label length if in Variable Length Mode, or the second fixed length if in Fixed Length Mode. Characters can be set from 0001 to 3,116 characters in increments of 0001 (pad with zeroes).

See [page 268](#) for detailed instructions on setting this feature.



Select Data Matrix Length 2 Setting

To configure this feature, scan the ENTER/EXIT PROGRAMMING MODE bar code above, then the bar code at left followed by the digits from the Alphanumeric characters in [Appendix D, Keypad](#) representing your desired character(s). End by scanning the ENTER/EXIT bar code again.

Make a mistake? Scan the CANCEL bar code to abort and not save the entry string. You can then start again at the beginning.



CANCEL

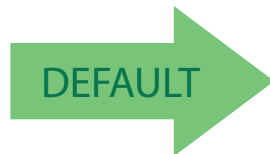

Length 2 is 3,116 Characters



MAXICODE

Maxicode Enable / Disable

Enables/disables ability of reader to decode Maxicode labels.

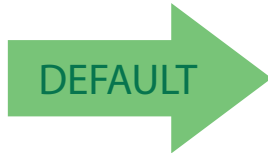

Maxicode = Disable



Maxicode = Enable

Maxicode Primary Message Transmission

Enables/disables the transmission of only the Primary Message when the Secondary Message is not readable.

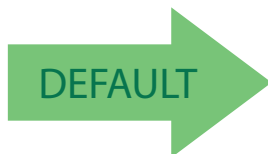

Maxicode Primary Message Transmission = Disable



Maxicode Primary Message Transmission = Enable



Maxicode Length Control

This feature specifies either variable length decoding or fixed length decoding for this symbology.

Variable Length: For variable length decoding, a minimum and maximum length may be set.

Fixed Length: For fixed length decoding, two different lengths may be set.

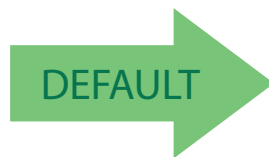

Maxicode Length Control = Variable Length



Maxicode Length Control = Fixed Length

Maxicode Set Length 1

Specifies one of the bar code lengths for **Maxicode Length Control**. Length 1 is the minimum label length if in **Variable Length Mode**, or the first fixed length if in **Fixed Length Mode**. Characters can be set from 0001 to 0145 characters in increments of 0001 (pad with zeroes).

See [page 267](#) for detailed instructions on setting this feature.



Select Maxicode Length 1 Setting

To configure this feature, scan the ENTER/EXIT PROGRAMMING MODE bar code above, then the bar code at left followed by the digits from the Alphanumeric characters in [Appendix D, Keypad](#) representing your desired character(s). End by scanning the ENTER/EXIT bar code again.

Make a mistake? Scan the CANCEL bar code to abort and not save the entry string. You can then start again at the beginning.



CANCEL

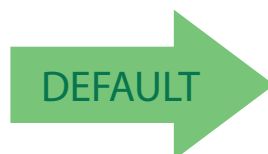

0001 = Length 1 is 1 Character



Maxicode Set Length 2

This feature specifies one of the bar code lengths for **Maxicode Length Control**. Length 2 is the maximum label length if in Variable Length Mode, or the second fixed length if in Fixed Length Mode. Characters can be set from 0001 to 0145 characters in increments of 0001 (pad with zeroes).

See [page 268](#) for detailed instructions on setting this feature.



Select Maxicode Length 2 Setting

To configure this feature, scan the ENTER/EXIT PROGRAMMING MODE bar code above, then the bar code at left followed by the digits from the Alphanumeric characters in [Appendix D, Keypad](#) representing your desired character(s). End by scanning the ENTER/EXIT bar code again.

Make a mistake? Scan the CANCEL bar code to abort and not save the entry string. You can then start again at the beginning.



CANCEL

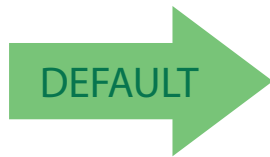

Length 2 is 0145 Characters



PDF417

PDF417 Enable / Disable

Enables/disables the ability of the reader to decode PDF417 labels.



PDF417 Length Control

This feature specifies either variable length decoding or fixed length decoding for this symbology.

Variable Length: For variable length decoding, a minimum and maximum length may be set.

Fixed Length: For fixed length decoding, two different lengths may be set.

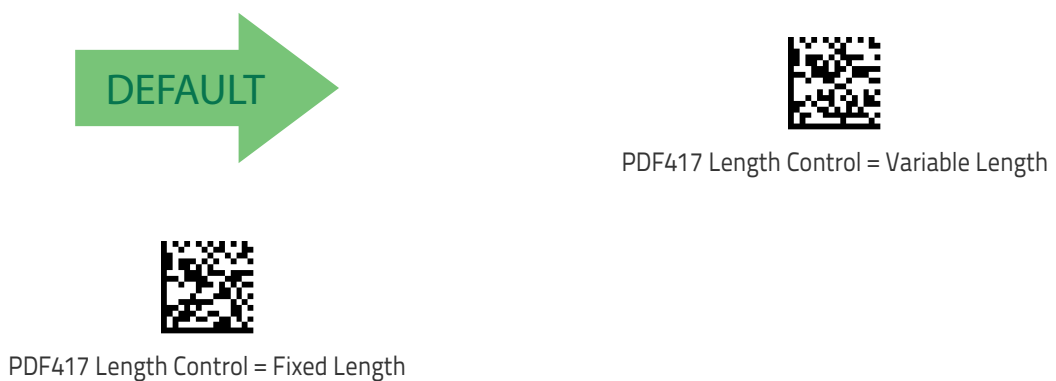



PDF417 Set Length 1

Specifies one of the bar code lengths for PDF417 Length Control. Length 1 is the minimum label length if in Variable Length Mode, or the first fixed length if in Fixed Length Mode. Length includes the bar code's data characters only. Characters can be set from 0001 to 2,710 characters (pad with zeroes) in increments of 01. Any value greater than 2,710 will be considered to be 2,710.

See [page 267](#) for detailed instructions on setting this feature.



Select PDF417 Length 1 Setting

To configure this feature, scan the ENTER/EXIT PROGRAMMING MODE bar code above, then the bar code at left followed by the digits from the Alphanumeric characters in [Appendix D, Keypad](#) representing your desired character(s). End by scanning the ENTER/EXIT bar code again.

Make a mistake? Scan the CANCEL bar code to abort and not save the entry string. You can then start again at the beginning.



CANCEL

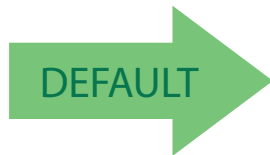

0001 = Length 1 is 1 Character



PDF417 Set Length 2

This feature specifies one of the bar code lengths for [PDF417 Length Control](#). Length 2 is the maximum label length if in Variable Length Mode, or the second fixed length if in Fixed Length Mode. Length includes the bar code's check, data, and full-ASCII shift characters. The length does not include start/stop characters. Characters can be set from 01 to 2,710 characters (pad with zeroes) in increments of 01. Any value greater than 2,710 will be considered to be 2,710.

See [page 268](#) for detailed instructions on setting this feature.



Select PDF417 Length 2 Setting

To configure this feature, scan the ENTER/EXIT PROGRAMMING MODE bar code above, then the bar code at left followed by the digits from the Alphanumeric characters in [Appendix D, Keypad](#) representing your desired character(s). End by scanning the ENTER/EXIT bar code again.

Make a mistake? Scan the CANCEL bar code to abort and not save the entry string. You can then start again at the beginning.



CANCEL

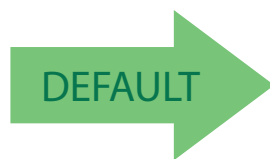

Length 2 is 2,710 Characters



MICRO PDF417

Micro PDF417 Enable / Disable

Enables/disables the ability of the reader to decode Micro PDF417 labels.

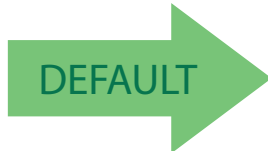

Micro PDF417 = Disable



Micro PDF417 = Enable

Micro PDF417 Code 128 GS1-128 Emulation

Specifies which AIM ID to use for MicroPDF labels when doing Code 128 or GS1-128 emulation.

Emulation choices are:

- Micro PDF AIM ID and label type
- Code 128 / EAN128 AIM Id and label type

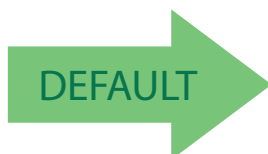

Micro PDF417 Code 128 GS1-128 Emulation =
Micro PDF AIM ID and label type



Micro PDF417 Code 128 GS1-128 Emulation =
Code 128 / EAN128 AIM ID and label type



Micro PDF417 Length Control

This feature specifies either variable length decoding or fixed length decoding for this symbology.

Variable Length: For variable length decoding, a minimum and maximum length may be set.

Fixed Length: For fixed length decoding, two different lengths may be set.

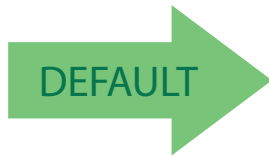

Micro PDF417 Length Control = Variable Length



Micro PDF417 Length Control = Fixed Length

Micro PDF417 Set Length 1

Specifies one of the bar code lengths for **Micro PDF417 Length Control**. Length 1 is the minimum label length if in **Variable Length Mode**, or the first fixed length if in **Fixed Length Mode**. Length includes the bar code's data characters only. Characters can be set from 0001 to 0366 characters (pad with zeroes) in increments of 01. Any value greater than 0366 will be considered to be 0366.

See [page 267](#) for detailed instructions on setting this feature.



Select Micro PDF417 Length 1 Setting

To configure this feature, scan the ENTER/EXIT PROGRAMMING MODE bar code above, then the bar code at left followed by the digits from the Alphanumeric characters in [Appendix D, Keypad](#) representing your desired character(s). End by scanning the ENTER/EXIT bar code again.

Make a mistake? Scan the CANCEL bar code to abort and not save the entry string. You can then start again at the beginning.



CANCEL

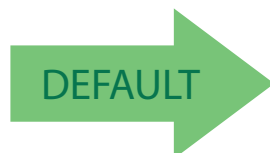

0001 = Length 1 is 1 Character



Micro PDF417 Set Length 2

This feature specifies one of the bar code lengths for **Micro PDF417 Length Control**. Length 2 is the maximum label length if in Variable Length Mode, or the second fixed length if in Fixed Length includes the bar code's data characters only. Characters can be set from 0001 to 0366 characters (pad with zeroes) in increments of 01. Any value greater than 0366 will be considered to be 0366.

See [page 268](#) for detailed instructions on setting this feature.



Select Micro PDF417 Length 2 Setting

To configure this feature, scan the ENTER/EXIT PROGRAMMING MODE bar code above, then the bar code at left followed by the digits from the Alphanumeric characters in [Appendix D, Keypad](#) representing your desired character(s). End by scanning the ENTER/EXIT bar code again.

Make a mistake? Scan the CANCEL bar code to abort and not save the entry string. You can then start again at the beginning.



CANCEL

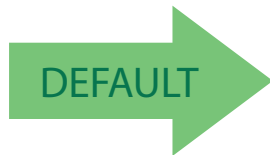

Length 2 is 0366 Characters



QR CODE

QR Code Enable / Disable

Enables/disables the ability of the reader to decode QR Code labels.



QR Code Length Control

This feature specifies either variable length decoding or fixed length decoding for this symbology.

Variable Length: For variable length decoding, a minimum and maximum length may be set.

Fixed Length: For fixed length decoding, two different lengths may be set.

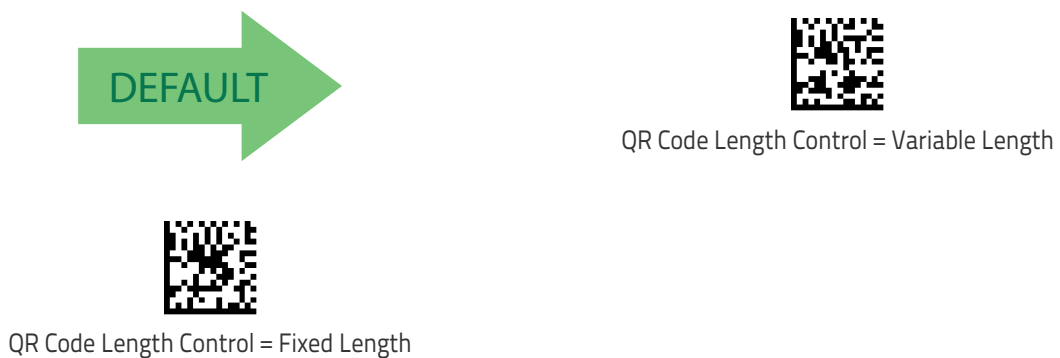



QR Code Set Length 1

Specifies one of the bar code lengths for **QR Code Length Control**. Length 1 is the minimum label length if in **Variable Length Mode**, or the first fixed length if in **Fixed Length Mode**. Characters can be set from 0001 to 7,089 characters in increments of 0001 (pad with zeroes).

See [page 267](#) for detailed instructions on setting this feature.



Select QR Code Length 1 Setting

To configure this feature, scan the ENTER/EXIT PROGRAMMING MODE bar code above, then the bar code at left followed by the digits from the Alphanumeric characters in **Appendix D, Keypad** representing your desired character(s). End by scanning the ENTER/EXIT bar code again.

Make a mistake? Scan the CANCEL bar code to abort and not save the entry string. You can then start again at the beginning.



CANCEL



0001 = Length 1 is 1 Character



QR Code Set Length 2

This feature specifies one of the bar code lengths for **QR Code Length Control**. Length 2 is the maximum label length if in Variable Length Mode, or the second fixed length if in Fixed Length Mode. Characters can be set from 0001 to 7,089 characters in increments of 0001 (pad with zeroes).

See [page 268](#) for detailed instructions on setting this feature.



Select QR Code Length 2 Setting

To configure this feature, scan the ENTER/EXIT PROGRAMMING MODE bar code above, then the bar code at left followed by the digits from the Alphanumeric characters in [Appendix D, Keypad](#) representing your desired character(s). End by scanning the ENTER/EXIT bar code again.

Make a mistake? Scan the CANCEL bar code to abort and not save the entry string. You can then start again at the beginning.



CANCEL

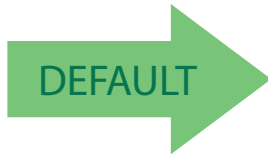

Length 2 is 7,089 Characters

MICRO QR CODE

Micro QR Code Enable/Disable

Enables/disables the ability of the reader to decode Micro QR Code labels.



Micro QR Code = Disable



Micro QR Code = Enable



Micro QR Code Length Control

This feature specifies either variable length decoding or fixed length decoding for this symbology.

Variable Length: For variable length decoding, a minimum and maximum length may be set.

Fixed Length: For fixed length decoding, two different lengths may be set.

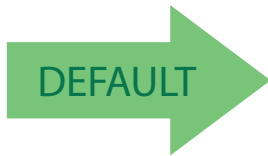

Micro QR Code Length Control = Variable Length



Micro QR Code Length Control = Fixed Length

Micro QR Code Set Length 1

Specifies one of the bar code lengths for Micro QR Code Length Control. Length 1 is the minimum label length if in **Variable Length Mode**, or the first fixed length if in **Fixed Length Mode**. Characters can be set from 0001 to 0035 characters in increments of 0001 (pad with zeroes).

See [page 267](#) for detailed instructions on setting this feature.



Select Micro QR Code Length 1 Setting

To configure this feature, scan the ENTER/EXIT PROGRAMMING MODE bar code above, then the bar code at left followed by the digits from the Alphanumeric characters in [Appendix D, Keypad](#) representing your desired character(s). End by scanning the ENTER/EXIT bar code again.

Make a mistake? Scan the CANCEL bar code to abort and not save the entry string. You can then start again at the beginning.



CANCEL

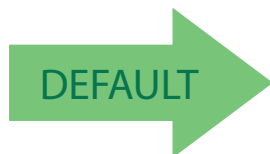

0001 = Length 1 is 1 Character



Micro QR Code Set Length 2

This feature specifies one of the bar code lengths for Micro QR Code Length Control. Length 2 is the maximum label length if in Variable Length Mode, or the second fixed length if in Fixed Length Mode. Characters can be set from 0001 to 0035 characters in increments of 0001 (pad with zeroes).

See [page 268](#) for detailed instructions on setting this feature.



Select QR Code Length 2 Setting

To configure this feature, scan the ENTER/EXIT PROGRAMMING MODE bar code above, then the bar code at left followed by the digits from the Alphanumeric characters in [Appendix D, Keypad](#) representing your desired character(s). End by scanning the ENTER/EXIT bar code again.

Make a mistake? Scan the CANCEL bar code to abort and not save the entry string. You can then start again at the beginning.



CANCEL

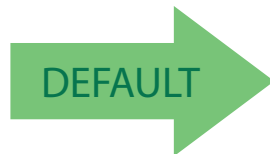

Length 2 is 0035 Characters



UCC COMPOSITE

UCC Composite Enable / Disable

Enables/disables the ability of the reader to decode the stacked part of a UCC Composite label.



This feature is not effective when Global AIM IDs are enabled (see "Global AIM ID" on page 51).

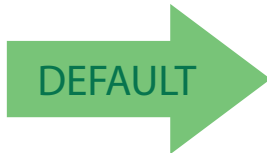

UCC Composite = Disable



UCC Composite = Enable



UCC Optional Composite Timer

Specifies the amount of time the system will wait for the stacked part of a UCC Composite label before transmitting the linear label without an add-on.

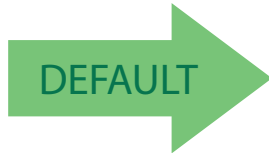

UCC Optional Composite Timer = Timer Disabled



UCC Optional Composite Timer = 100msec



UCC Optional Composite Timer = 200msec



UCC Optional Composite Timer = 300msec



UCC Optional Composite Timer = 400msec



UCC Optional Composite Timer = 500msec



POSTAL CODE SELECTION

Enables/disables the ability of the scanner to decode labels of a specific postal symbology.

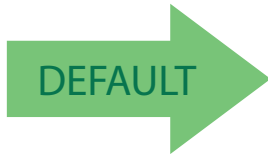

Postal Code Selection = Disable All Postal Codes



Postal Code Selection = Enable Postnet



Postal Code Selection = Enable Planet



Postal Code Selection = Enable Royal Mail



Postal Code Selection = Enable Kix



Postal Code Selection = Enable Australia Post



Postal Code Selection (continued)



Postal Code Selection = Enable Japan Post



Postal Code Selection = Enable IMB



Postal Code Selection = Enable Sweden Post



Postal Code Selection = Enable Portugal Post

Postnet BB Control

Controls the ability of the scanner to decode B and B' fields of Postnet labels.

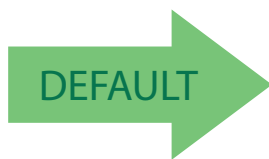

Postnet BB Control = Disable



Postnet BB Control = Enable

NOTES

MOTION FEATURES

MOTION AIMING CONTROL on page 205
MOTION SENSITIVITY on page 206
MOTIONLESS TIMEOUT on page 206

Use this chapter to configure motion settings for the handheld. Reference [Appendix C](#), for a listing of standard factory settings.

Motion Aiming Control

Configures the ability of the scanner to Enable/Disable the Aiming system when motion is detected.



Motion Aiming Control = Disable



Motion Aiming Control = Enable





Enter/Exit Programming Mode

Motion Sensitivity

Defines discrete set of levels for scanner motion sensitivity when in hand-held use.

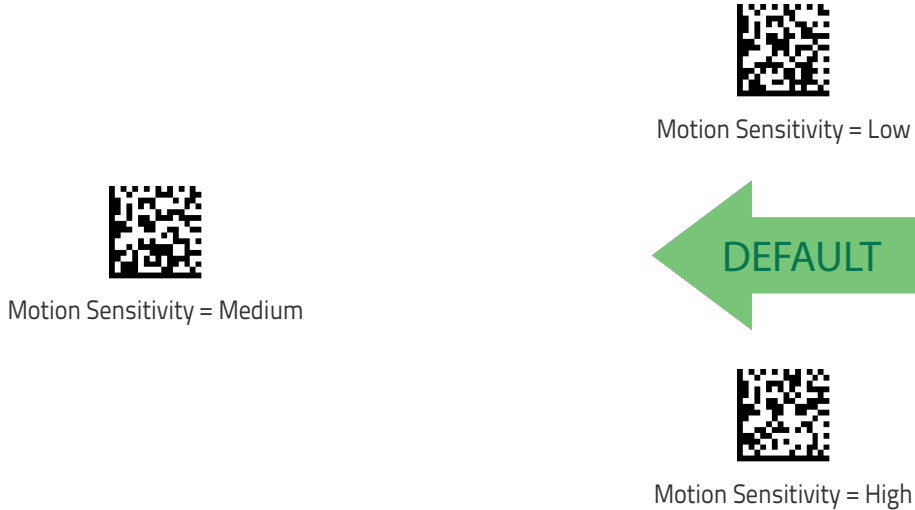

Motionless Timeout

Specifies the waiting time in 100 millisecond ticks to assume that the reader is in a motionless condition. The selectable range is 500 msec to 25.5 Seconds. When no motion event is detected for a period of time longer than this timeout, the software assumes the reader is in a motionless condition. This option relates to such features as Aimer On and Stand Mode Object Sense scanning with respect to motion. See "Motionless Timeout" on page 287 in References.



To configure this feature, scan the ENTER/EXIT PROGRAMMING MODE bar code above, then the bar code at left followed by three digits from the Alpha-numeric characters in [Appendix D, Keypad](#) representing your desired character(s). End by scanning the ENTER/EXIT bar code again.

Make a mistake? Scan the CANCEL bar code to abort and not save the entry string. You can then start again at the beginning.



CANCEL

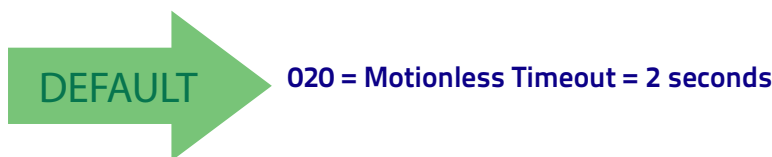

WIRELESS FEATURES

This section provides options and programming related to the reader's wireless communication features. Reference [Appendix C](#), for a listing of standard factory settings.

WIRELESS BEEPER FEATURES starting on page 209

- "Good Transmission Beep" on page 209
- "Beep Frequency" on page 209
- "Beep Duration" on page 210
- "Beep Volume" on page 211
- "Disconnect Beep" on page 211
- "Docking Beep" on page 212
- "Leash Alarm" on page 212

CONFIGURATION UPDATES starting on page 214

- Automatic Configuration Update on page 214
- Copy Configuration to Scanner on page 214
- Copy Configuration to Base Station on page 214

BATCH FEATURES starting on page 215

- Batch Mode on page 215
- Send Batch on page 215
- Erase Batch Memory on page 216
- RF Batch Mode Transmit Delay on page 216

DIRECT RADIO AUTOLINK starting on page 217

RF ADDRESS STAMPING starting on page 217

- Source Radio Address Transmission on page 217
- Source Radio Address Delimiter Character on page 218

REAL TIME CLOCK (RTC) CONFIGURATION starting on page 219

- Current Date on page 219
- Current Time on page 219
- Date Tx Format on page 220
- Time Tx Format on page 220
- Date-Time Separator on page 221
- Date-Time Transmission Order on page 222

PBT9500-Only Features

BLUETOOTH SECURITY FEATURES starting on page 223

- Bluetooth Security Mode on page 224
- Bluetooth PIN Code on page 224
- Select PIN Code Length on page 224
- Set PIN Code on page 225



PBT9500-Only Features (continued)

OTHER BLUETOOTH FEATURES starting on page 226

- Bluetooth Poll Rate on page 226
- Power Off on page 227
- Powerdown Timeout on page 227
- Bluetooth HID Variable PIN Code on page 228
- Bluetooth HID Alt Mode on page 229
- Bluetooth HID Send Unknown ASCII Char on page 229
- Bluetooth Max Client on page 230
- Bluetooth Friendly Name on page 231
- Bluetooth Reconnect Attempt Mode on page 231
- HID Country Mode on page 232

PM9500-Only Features

- STAR Radio Protocol Timeout on page 235
- STAR Radio Transmit Mode on page 236
- Changing System Speed on page 237

COMPATIBILITY WITH PM8500 starting on page 238

- Compatibility mode on page 238
- Changing from Normal to Compatible Mode on page 238
- Changing from Compatible Mode back to Normal on page 239
- Base Address Stamping on page 240
- Base Address Delimiter Character on page 240
- RS-485 Master Header/Terminator (Prefix/Suffix) on page 241
- RS-485 Cradle Address on page 241
- RS-485 Slave Minimum Address on page 242
- RS-485 Slave Maximum Address on page 242
- RS-485 Network Working Mode on page 243
- RS-485 Network Warning Message on page 243
- RS-485 Transmission Warning Message on page 244
- RS-485 Network Baud Rate on page 244

Display and Keyboard Features

- Display Operating Mode on page 245
- Display Off Timeout on page 246
- Backlight Enable on page 246
- Display Contrast on page 247
- Font Size on page 247
- Enable/disable buttons on page 248
- Action Configuration for Function Keys on page 250
- Define Strings on page 251
- Set String ID on page 252
- Set String Header on page 252
- Set String Terminator on page 253



WIRELESS BEEPER FEATURES

Several options are available to configure beeper behavior for RF operation.

Good Transmission Beep

Enables/disables the Good Transmission Beep indication. When enabled, a beep occurs when a Label is correctly transmitted to the base.



Good Transmission Beep = Disable



Good Transmission Beep = Enable



Beep Frequency

Adjusts radio-specific beep indications to sound at a low, medium or high frequency, selectable from the list below (controls the beeper's pitch/tone).

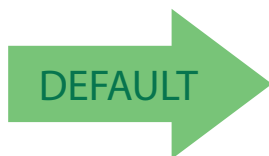

Beep Frequency = Low



Beep Frequency = Medium



Beep Frequency = High



Beep Duration

This feature controls the duration of radio-specific beep indications.



Beep Duration = 60 msec



Beep Duration = 80 msec



Beep Duration = 100 msec



Beep Duration = 120 msec



Beep Duration = 140 msec



Beep Duration = 160 msec



Beep Duration = 180 msec



Beep Duration = 200 msec



Beep Volume

Selects the beeper volume (loudness) of radio-specific beep indications. There are three selectable volume levels.



Beep Volume = Low



Beep Volume = Medium



Beep Volume = High



Disconnect Beep

Enables/disables the beep indication that a handheld has become connected or disconnected from a Base Station.



The defaults are different for the STAR and Bluetooth models.



Disconnect Beep = Disable



Disconnect Beep = Enable





Enter/Exit Programming Mode

Docking Beep

Enables/disables a beep indication when the handheld is placed in the Base Station.



Leash Alarm

This setting specifies the number of seconds to sound the Leash Mode beeps (three per second) when the handheld goes out of range. This is especially useful in instances where the reader might inadvertently have been placed in a bag or cart.

For this mode to be effective, the reader must be linked to the Base Station. If the reader is asleep or disconnected from the Base Station, there is no way for it to know where it is relative to the Base Station because communication is not active between the devices.

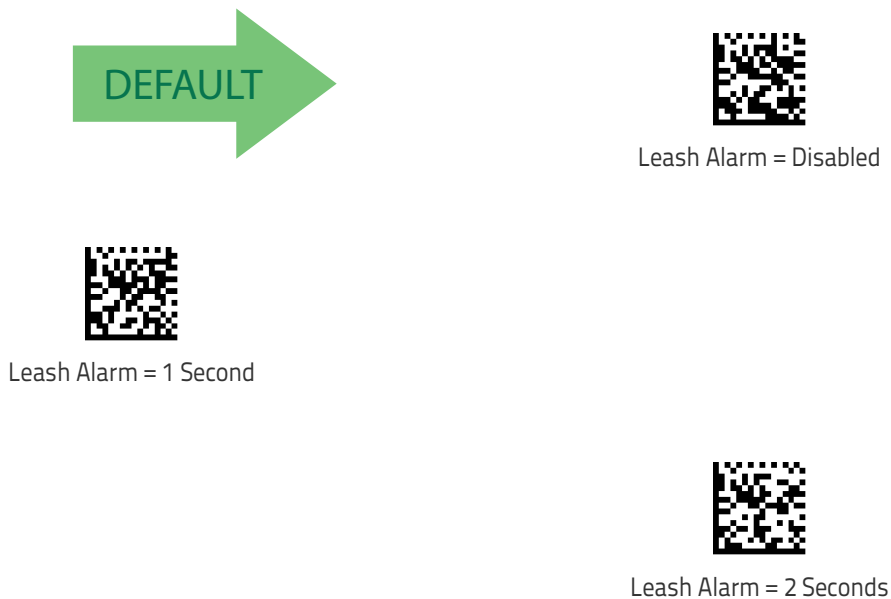



Leash Alarm (continued)



Leash Alarm = 3 Seconds



Leash Alarm = 4 Seconds



Leash Alarm = 5 Seconds



Leash Alarm = 10 Seconds



Leash Alarm = 25 Seconds



Leash Alarm = 30 Seconds



CONFIGURATION UPDATES

See [page 288](#) in “References” for detailed information and examples of these features.

Automatic Configuration Update

When this feature is enabled, a reader and its linked Base Station can automatically ensure they stay in sync with regard to application hardware and/or configuration. See [page 288](#) for more information on this feature.



Automatic Configuration Update = Disable



Automatic Configuration Update = Enable



Copy Configuration to Scanner

Scan the following label to copy the current Base Station configuration to the scanner. Use this method when the Auto Configuration Update feature is disabled and you want a one-time configuration update to be performed on the scanner.



Do not scan an ENTER/EXIT PROGRAMMING MODE label in conjunction with this bar code.



Copy Configuration to Scanner

Copy Configuration to Base Station

Scan the following label to copy the current scanner configuration to the Base Station. Use this method when the Auto Configuration Update feature is disabled and you want a one-time configuration update to be performed on the Base Station.



Copy Configuration to Base Station



Do not scan an ENTER/EXIT PROGRAMMING MODE label with this bar code.



BATCH FEATURES

Batch Mode

This option specifies whether to store labels in the handheld while disconnected from the base. Options are as follows:

- Disabled — The handheld will not store/batch labels.
- Automatic — The handheld will store labels to RAM when the handheld goes out of range and is disconnected from the remote device.
- Manual — The handheld will always store labels to Flash memory. The user must manually send the stored labels to the remote device using a special "batch send" label.

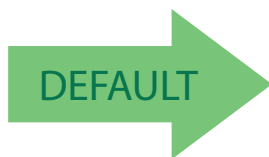

Batch Mode = Disabled



Batch Mode = Automatic



Batch Mode = Manual

Send Batch

When the scanner is configured in Manual Batch Mode, use the following bar code to initiate sending of labels stored in batch memory.



Do not scan an ENTER/EXIT PROGRAMMING MODE label in conjunction with this bar code.



Send Batch



Erase Batch Memory

When the scanner is configured in Manual Batch Mode, use the following bar code to erase any labels stored in batch memory.



Do not scan an ENTER/EXIT PROGRAMMING MODE label in conjunction with this bar code.



Erase Batch Memory

RF Batch Mode Transmit Delay

Specifies the delay in 10 msec increments between transmitting labels stored in batch memory.

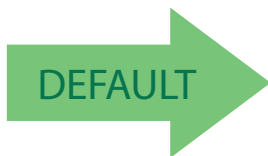

RF Batch Mode Transmit Delay = No Delay



RF Batch Mode Transmit Delay = 50 mS



RF Batch Mode Transmit Delay = 100 mS



RF Batch Mode Transmit Delay = 0.5 seconds



RF Batch Mode Transmit Delay = 1 second



RF Batch Mode Transmit Delay = 2.5 seconds



DIRECT RADIO AUTOLINK

This feature enables/disables the ability to link a wireless handheld to a base station without scanning the Unlink label first.

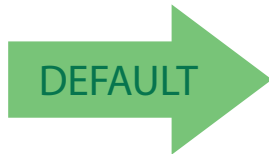

Direct Radio Link = Unlink Label Required



Direct Radio Link = Automatic Unlinking

RF ADDRESS STAMPING

These features allow configuration of source radio data inclusion.

Source Radio Address Transmission

Enables/disables the ability of source radio address information to be transmitted to the host and, if so, at what position with respect to the label data. See [page 288](#) in “References” for detailed information and examples for setting this feature.



When included as a prefix, the source-radio ID is displayed after all label formatting has been applied. The 6 byte hex address is sent as 12 ascii characters, i.e., an address of 00 06 66 00 1A ED will be sent as (shown in hex): 30 30 30 36 36 36 30 30 31 41 45 44



Source Radio Address Transmission = Do Not Include



Source Radio Address Transmission = Prefix



Source Radio Address Delimiter Character

This option specifies the delimiter character to be placed between the label data and radio address when address stamping is enabled.



This feature only applies if "Source Radio Address Transmission" on page 217 is enabled.



Set Source Radio Address Delimiter Character

To configure this feature, scan the ENTER/EXIT PROGRAMMING MODE bar code above, then the bar code at left followed by the digits from the Alphanumeric characters in [Appendix D, Keypad](#) representing your desired character(s). End by scanning the ENTER/EXIT bar code again.

Make a mistake? Scan the CANCEL bar code to abort and not save the entry string. You can then start again at the beginning.



CANCEL

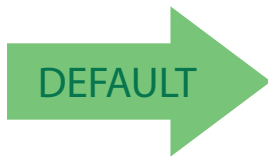

00 = No Delimiter Character



REAL TIME CLOCK (RTC) CONFIGURATION

Current Date

Sets the date of the internal Real Time Clock (RTC)



Set Current Date = YYMMDD

To configure this feature, scan the ENTER/EXIT PROGRAMMING MODE bar code above, then the bar code at left followed by the digits from the Alphanumeric characters in [Appendix D, Keypad](#) representing your desired character(s). End by scanning the ENTER/EXIT bar code again.

Make a mistake? Scan the CANCEL bar code to abort and not save the entry string. You can then start again at the beginning.



CANCEL

Current Time

Sets the time of the internal Real Time Clock (RTC). HH = 24 hours format



Set Current Time = HHMMSS

To configure this feature, scan the ENTER/EXIT PROGRAMMING MODE bar code above, then the bar code at left followed by the digits from the Alphanumeric characters in [Appendix D, Keypad](#) representing your desired character(s). End by scanning the ENTER/EXIT bar code again.

Make a mistake? Scan the CANCEL bar code to abort and not save the entry string. You can then start again at the beginning.



CANCEL



Date Tx Format

Sets the format of the date.

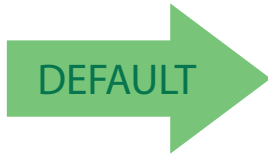

YYYY-MM-DD (ISO 8601)



YYYYMMDD (No ISO)



MMDDYYYY



DDMMYYYY

Time Tx Format

Sets the format of the time.

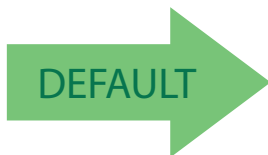

hh:mm:ss (ISO 8601)



hhmmss (No ISO)



Date-Time Separator

Sets the character used to separate Date and Time from the next field in message.

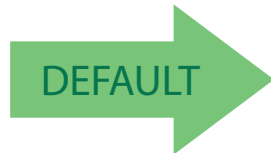

Set Character Separator =

Make a mistake? Scan the CANCEL bar code to abort and not save the entry string. You can then start again at the beginning.



Disable Date-Time Separator

To configure this feature, scan the ENTER/EXIT PROGRAMMING MODE bar code above, then the bar code at left followed by 2 digits from the Alphanumeric characters in [Appendix D, Keypad](#) representing your desired character(s). End by scanning the ENTER/EXIT bar code again.



CANCEL



Date-Time Transmission Order

Allows the selection of the order of date and time transmission.



Disabled



DEFAULT



ISO 8601: Date'TT'ime



DateTime



TimeDate



Date



Time



PBT9500-ONLY FEATURES

The features in this section are valid only for PBT9500 Bluetooth models. Also reference the Setup section for instructions on [Linking the Reader](#), starting on page 19.

BLUETOOTH SECURITY FEATURES

On the Bluetooth system, it is possible to set a (configurable) PIN code to authenticate/connect Bluetooth devices, and encrypt the data.

The Bluetooth PIN code can be enabled and configured by reading the bar codes in the following sections.



If you are using a Bluetooth scanner directly connected to a host through a Bluetooth dongle, verify that the scanner and the Bluetooth driver used by the dongle share the same PIN code and the same security level. Otherwise the connection cannot be established.

Follow these steps to set the PIN code for a scanner:

1. **Enable Bluetooth Security Mode** by scanning the “Enable” bar code below.
2. **Select a PIN code length** of either 4 or 16 characters by scanning the appropriate bar code in “[Select PIN Code Length](#)” on page 224.
3. Scan the relevant bar code from “[Set PIN Code](#)” on page 225, then scan the desired alphanumeric characters from the keypad in [Appendix D, Keypad](#) to set the PIN code.

See [page 290](#) in “References” for more detailed information and examples for this feature.



Bluetooth Security Mode

This feature enables/disables authentication and encryption of the Bluetooth link. Use the feature "Bluetooth PIN Code" on page 224 to specify the length and digits in the PIN code used to authenticate the Bluetooth Link.



Changing the security mode setting will unlink the devices. If the Automatic Configuration Update is set to the default "Enabled" setting, the devices must only be relinked. If the Automatic Configuration Update is set to "Disabled," the Security Mode setting must also be updated in the Base Station using Aladdin. After the Base Station has been updated, the devices must be relinked.

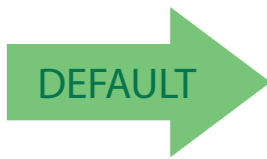

Bluetooth Security Mode = Disable



Bluetooth Security Mode = Enable

Bluetooth PIN Code

After enabling Security Mode (see "Bluetooth Security Mode" on page 224), specify whether you want to set a 4-digit or a 16-digit PIN Code. See page 290 for detailed information and examples for setting this feature.

Select PIN Code Length



Select 4-character Bluetooth PIN Code



Select 16-character Bluetooth PIN Code



Set PIN Code

Determine the desired characters for the PIN code, then convert to hexadecimal using the [ASCII Chart on page 1](#) on the inside back cover of this manual. See [page 290](#) for detailed information and examples for setting this feature.



Set 4-character Bluetooth PIN Code

To configure this feature, scan the ENTER/EXIT PROGRAMMING MODE bar code above, then the bar code at left followed by the hexadecimal digits from the Alphanumeric characters in [Appendix D, Keypad](#) representing your desired character(s). End by scanning the ENTER/EXIT bar code again.



Set 16-character Bluetooth PIN Code



CANCEL

Make a mistake? Scan the CANCEL bar code to abort and not save the entry string. You can then start again at the beginning.

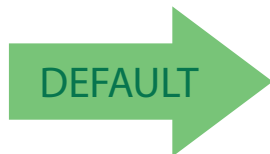

31323334 = Default PIN Code is 1234



OTHER BLUETOOTH FEATURES

Bluetooth Poll Rate

This feature specifies the time between Bluetooth polls.



Bluetooth Poll Rate = Maximum Bluetooth Poll Rate



Bluetooth Poll Rate = 10 ms



Bluetooth Poll Rate = 20 ms



Bluetooth Poll Rate = 50 ms



Bluetooth Poll Rate = 100 ms



Bluetooth Poll Rate = 200 ms



Power Off

See “Power Off” on page 20 for information about this Bluetooth feature.

Powerdown Timeout

The Powerdown Timeout feature sets the time for automatically switching the unit off when the imager has been idle.



Powerdown Timeout = Disable



Powerdown Timeout = 10 minutes



Powerdown Timeout = 20 minutes



Powerdown Timeout = 30 minutes



Powerdown Timeout = 60 Minutes (1 Hour)



Powerdown Timeout = 120 Minutes (2 Hours)



Bluetooth HID Variable PIN Code

Specifies the selection available for Static or Variable Pin Code, when Bluetooth HID profile is configured.

Some Bluetooth drivers on the Host (such as WIDCOMM and BlueSoleil 8) require a Variable PIN Code. When attempting connection, the application presents a window that includes a PIN Code which is to be input using the PowerScan BT9500. Scan the bar code "Variable PIN Code" below, then use the host computer's Bluetooth manager to "Discover new devices" and select "Datalogic Scanner." Use a text editor to see incoming data on the port designated by the computer's Bluetooth manager.



If you receive an error message, it may be necessary to disable security on the device.

When you hear the beep and see the Green LED blinking indicating the reader is waiting for an alphanumeric entry, enter the required variable PIN Code by scanning the corresponding bar codes in [Appendix D, Keypad](#) for alphanumeric entry. Finish by scanning the Exit HID Variable PIN Code label.



Set Static Pin Code



Set Variable Pin code



CANCEL

Make a mistake? Scan the CANCEL bar code to abort and not save the entry string. You can then start again at the beginning.



Exit HID Variable PIN Code



Bluetooth HID Alt Mode

Enable/Disable the ability to correctly transmit a label to the host regardless of the Bluetooth HID Country Mode selected, when Bluetooth HID Profile is configured.

Read the configuration command label below for the HID Alt Mode feature.



HID Alt Mode = OFF



HID Alt Mode = ON

Bluetooth HID Send Unknown ASCII Char

Unknown characters are characters the host does not recognize. When Disable HID Send ASCII Unknown character is selected, all barcode data is sent except for unknown characters, and an error beep will sound. When *HID Send Unknown ASCII character* is enabled, an unknown character will be sent as a SPACE.

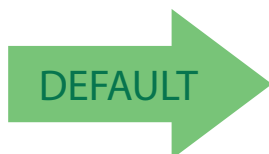

HID Send Unknown ASCII character = Disable



HID Send Unknown ASCII character = Enable



Bluetooth Max Client

Set the number of Readers that can connect to the Base in a Piconet network.



Bluetooth Max Client = 1



Bluetooth Max Client = 2



Bluetooth Max Client = 3



Bluetooth Max Client = 4



Bluetooth Max Client = 5



Bluetooth Max Client = 6



Bluetooth Max Client = 7



Bluetooth Friendly Name

You can set a meaningful name for PowerScan BT9500 that will appear in the application during device discovery.

To set a new Bluetooth Friendly Name, scan the barcode below and follow the instructions.



Set Bluetooth Friendly Name

To configure this feature, scan the ENTER/EXIT PROGRAMMING MODE bar code above, then the bar code at left followed by a maximum 64 digits from the Alphanumeric characters in [Appendix D, Keypad](#). The digits must be the hexadecimal ASCII representation of the desired characters. If less than the expected string of 32 characters are selected, scan the ENTER/EXIT bar code to terminate the string.

Make a mistake? Scan the CANCEL bar code to abort and not save the entry string. You can then start again at the beginning.



CANCEL

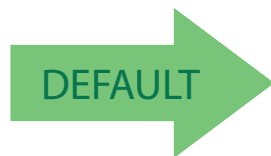

POWERSCAN BT9500
[SERIAL_NUMBER_SCANNER]

Bluetooth Reconnect Attempt Mode

Enable/Disable reconnection by trigger pull.



Bluetooth Reconnect Attempt Mode = Disable



Bluetooth Reconnect Attempt Mode = Enable





HID Country Mode

When the Reader is connected with a Bluetooth Adapter in HID mode, you may want to set the country for which your PC is localized. In order to do that, read one of the configuration command labels below.



Country Mode = U.S.



Country Mode = Belgium



Country Mode = Britain



Country Mode = Croatia



Country Mode = Czech Republic



Country Mode = Denmark



Country Mode = France



HID COUNTRY MODE (continued)



Country Mode = French Canadian



Country Mode = Germany



Country Mode = Hungary



Country Mode = Italy



Country Mode = Japanese 106-key



Country Mode = Lithuanian



Country Mode = Norway



Country Mode = Poland



Country Mode = Portugal



Enter/Exit Programming Mode

HID COUNTRY MODE (continued)



Country Mode = Romania



Country Mode = Spain



Country Mode = Sweden



Country Mode = Slovakia



Country Mode = Switzerland



PM9500-ONLY FEATURES

The features in this section are valid only for the PowerScan PM9500 Star model:

- STAR Radio Protocol Timeout on page 235
- STAR Radio Transmit Mode on page 236

STAR Radio Protocol Timeout

This parameter sets the valid wait time before transmission between the handheld reader and Base Station is considered failed.

When setting this parameter, take into consideration the radio traffic (number of readers in the same area). The selectable range for this feature is from 02 to 25 seconds. See page 289 in “References” for detailed information and examples for setting this feature.



Set Radio Protocol Timeout

To configure this feature, scan the ENTER/EXIT PROGRAMMING MODE bar code above, then the bar code at left followed by two digits from the Alpha-numeric characters in [Appendix D, Keypad](#) representing your desired character(s). End by scanning the ENTER/EXIT bar code again.

Make a mistake? Scan the CANCEL barcode to abort and not save the entry string. You can then start again at the beginning.



CANCEL

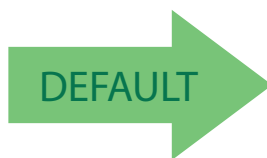

02 = 2 Seconds Radio Protocol Timeout



STAR Radio Transmit Mode

Specifies the transmission protocol for Star communications.

Options are:

- ACK from cradle to scanner — signals a good transmission as soon as the Base Station receives a label
- ACK when sent to host — scanner signals a good transmission as soon as the Base Station has sent the label to the host
- ACK from host — scanner signals a good transmission as soon as the Base Station has sent the label to the host and host has replied with an acknowledge message.

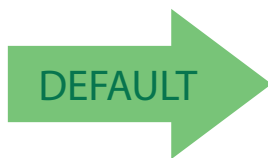

ACK from cradle



ACK when sent to host

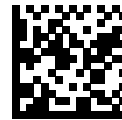

ACK from host



ACK from host works only for RS-232 or USB-COM interfaces with ACK/NACK disabled. If ACK from host is configured with any other interface conditions, it works like ACK when sent to host. See "Message Formatting" on page 293 for details.

For this feature to be operational, the scanner must be set to Ignore Host Commands (see page 23).



The Base Station can receive a host message only if Host Commands Obey/Ignore (page 23) is set to Ignore.



Changing System Speed

1. Link the PM9500 with a BC9xxx Base.
2. With the PM9500, read a “Compatible Mode/Normal Mode Speed” programming label on [page 238](#) to set “Low, Medium, or High Speed”.
3. Place the PM9500 into the BC9xxx.

The Reader and Base will now be linked at the new programmed speed.

This feature can also be programmed using Datalogic Aladdin.

1. On the BC9xxx Base, change the Compatible mode parameter to low, intermediate, or high speed through Aladdin.
2. Place an unlinked PM9500 onto the BC9xxx base.

The Reader and base will link at the new programmed speed.



COMPATIBILITY WITH PM8500

Compatibility mode

Powerscan PM9500 offers a limited set of features compatible with the previous PM8500 family. To access those features, you have to program the system through the Compatible Mode parameter.

When in normal mode, the same parameter can be used to configure the communication speed.



You must read the barcode "Restore Custom Defaults" on page 18 when switching from normal mode to compatible mode, or vice-versa.

Changing from Normal to Compatible Mode

PM9500 Handheld

1. With the PM9500, read the Compatible Mode (0) bar code below.
2. Now you can link your PM9500 with a BC8xxx as if it were a PM8500, assigning an address to the reader and performing a Join or Bind (see the **Set Radio Address** and **Bind** commands in the PM8500 QRG).



When the PM9500 is in Compatible Mode, some newer features (such as communication speed programming) will not be available.



Compatible Mode (0)



Normal Mode: Low Speed (1)



Normal Mode: Intermediate Speed (2)



Normal Mode: High Speed (3)





BC9xxx Base

The BC9xxx can be changed from Normal to Compatible mode using the Aladdin configuration tool. See "Datalogic Aladdin™" on page 6 for more information. This will allow you to Join or Bind a PM9500 to your BC9xxx.

Changing from Compatible Mode back to Normal

PM9500 Handheld

1. With the PM9500, read a Compatible mode programming label on [page 238](#) with a value of "Low, Medium, or High Speed".
2. With the PM9500, read the Unlink programming label.
3. Now you can link your PM9500 to a BC9xxx in normal mode; the PM9500 will inherit the programmed speed from the BC9xxx.

BC9xxx Base

1. Using Datalogic Aladdin, change the Compatible Mode parameter to "Low, Medium, or High Speed".
2. Now you can link a previously unlinked PM9500; the reader will inherit the speed programmed in the BC9xxx.

If Aladdin is not available, use the following procedure:

1. With a PM9500 in normal mode, read the Unlink programming label on [page 19](#), then read the following bar code:



Return to Normal



Do not scan an ENTER/EXIT PROGRAMMING MODE label with this bar code.

2. Place the same PM9500 on your BC9xxx.

Your BC9xxx will link to the PM9500 and will inherit the reader's programmed speed.



Base Address Stamping

Enables/disables the ability of base address information to be transmitted to the host and, if so, at what position with respect to the label data. See page 288 in "References" for detailed information and examples for setting this feature.

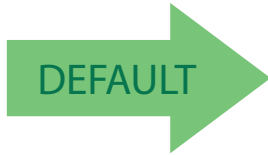

Base Address Transmission = Do Not Include



Base Address Transmission = Prefix

Base Address Delimiter Character

This option specifies the delimiter character to be placed between the label data and base address when address stamping is enabled.



This feature only applies if "Base Address Stamping" on page 240 is enabled.



Set Base Address Delimiter Character

To configure this feature, scan the ENTER/EXIT PROGRAMMING MODE bar code above, then the bar code at left followed by two digits from the Alphanumeric characters in Appendix D, Keypad representing your desired character. End by scanning the ENTER/EXIT bar code again.

Make a mistake? Scan the CANCEL bar code to abort and not save the entry string. You can then start again at the beginning.



CANCEL



00 = No Delimiter Character



RS-485 Master Header/Terminator (Prefix/Suffix)

Specifies the Master Cradle header or terminator characters to be added to a label sent to Host. The characters may be added as a prefix (in a position before the bar code data, also called a header) and/or as a suffix (in a position following the bar code data, also called a terminator).

To configure this feature, scan the ENTER/EXIT PROGRAMMING MODE bar code above to place the unit in Programming Mode, then the “Set Master Cradle Prefix” or “Set Master Cradle Suffix” bar code followed by the digits (in hex) from the Alphanumeric characters in [Appendix D, Keypad](#) representing your desired character(s). If less than the expected string of 8 characters are selected, scan the ENTER/EXIT bar code to terminate the string. Exit programming mode by scanning the ENTER/EXIT bar code again.



Set Master Cradle Prefix



Set Master Cradle Suffix

Make a mistake? Scan the CANCEL bar code to abort and not save the entry string. You can then start again at the beginning.



CANCEL

RS-485 Cradle Address

Specifies the Address for the Cradle in the RS-485 network..



Set Cradle Address

To configure this feature, scan the ENTER/EXIT PROGRAMMING MODE bar code above, then the bar code at left followed by the digits from the Alphanumeric characters in [Appendix D, Keypad](#) representing your desired character(s). End by scanning the ENTER/EXIT bar code again.

Make a mistake? Scan the CANCEL bar code to abort and not save the entry string. You can then start again at the beginning.



CANCEL



Enter/Exit Programming Mode

RS-485 Slave Minimum Address

Specifies the minimum address that can be set for a Cradle in an RS-485 network.



The maximum number of cradles in a single network is 16 (including the Master if present). All cradles in the system must have different addresses.



Slave Minimum Address

To configure this feature, scan the ENTER/EXIT PROGRAMMING MODE bar code above, then the bar code at left followed by four digits from the Alphanumeric characters in [Appendix D, Keypad](#) representing your desired character(s). End by scanning the ENTER/EXIT bar code again.

Make a mistake? Scan the CANCEL bar code to abort and not save the entry string. You can then start again at the beginning.



CANCEL

RS-485 Slave Maximum Address

Specifies the maximum address that can be set for a Cradle in an RS-485 network.



The maximum number of cradles in a single network is 16 (including the Master if present). All cradles in the system must have different addresses.



Slave Maximum Address

To configure this feature, scan the ENTER/EXIT PROGRAMMING MODE bar code above, then the bar code at left followed by four digits from the Alphanumeric characters in [Appendix D, Keypad](#) representing your desired character(s). End by scanning the ENTER/EXIT bar code again.

Make a mistake? Scan the CANCEL bar code to abort and not save the entry string. You can then start again at the beginning.



CANCEL



RS-485 Network Working Mode

Specifies the selection available for Cradle working mode in an RS-485 network.



Disable Network



Enable RS-485 Slave



Enable RS-485 Master

RS-485 Network Warning Message

Enable/Disable the ability of Cradle to transmit warning messages to the Host regarding some RS-485 network errors.



Not Transmitted



Transmitted



RS-485 Transmission Warning Message

Enable/Disable the ability of the cradle to transmit warning messages to the Host regarding wrong reception of data.

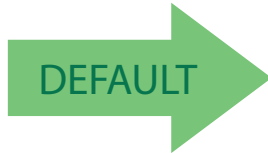

Not Transmitted



Transmitted

RS-485 Network Baud Rate

Specifies the baud rate of an RS-485 network.

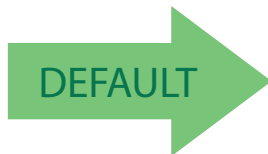

Baud Rate 9600



Baud Rate 19200



Baud Rate 34800



DISPLAY AND KEYBOARD FEATURES

Display Operating Mode

Select the operating mode of the display. Options are:

- **Normal Mode:** Display not cleared, no echo of the code on Display.
- **Local Echo:** Display cleared after decode, echo of the code on display.
- **Clear display after decode:** Display is cleared after decode, no echo.



Normal Mode = Display not cleared



Local echo mode



Clear display after decode



Display Off Timeout

Sets the timeout for display, backlight and keyboard.



Set Display Off Timeout



Display Off Timeout = Disabled

To configure this feature, scan the ENTER/EXIT PROGRAMMING MODE bar code above, then the bar code at left followed by two digits from the Alphanumeric characters in [Appendix D, Keypad](#) representing your desired character(s). End by scanning the ENTER/EXIT bar code again.

Make a mistake? Scan the CANCEL bar code to abort and not save the entry string. You can then start again at the beginning.



CANCEL

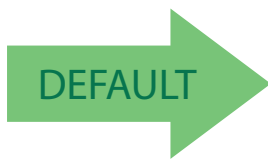

08 = 8 second delay

Backlight Enable

Enables/Disables the display backlight.

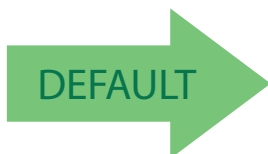

Backlight Disabled



Backlight Enabled



Display Contrast

Adjust the contrast of the display.



Set Display Contrast

To configure this feature, scan the ENTER/EXIT PROGRAMMING MODE bar code above, then the bar code at left followed by two digits (00-32 by 01) from the Alpha-numeric characters in [Appendix D, Keypad](#) representing your desired character(s). End by scanning the ENTER/EXIT bar code again.

Make a mistake? Scan the CANCEL bar code to abort and not save the entry string. You can then start again at the beginning.

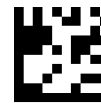

CANCEL

Font Size

Select the font size.

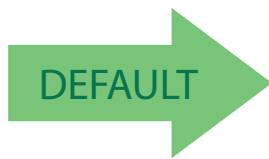

Font Size = Small



Font Size = Medium



Font Size = Large



Enable/disable buttons

This feature offers the ability to enable or disable each key independently.

Figure 6. PowerScan 9500 Keypad

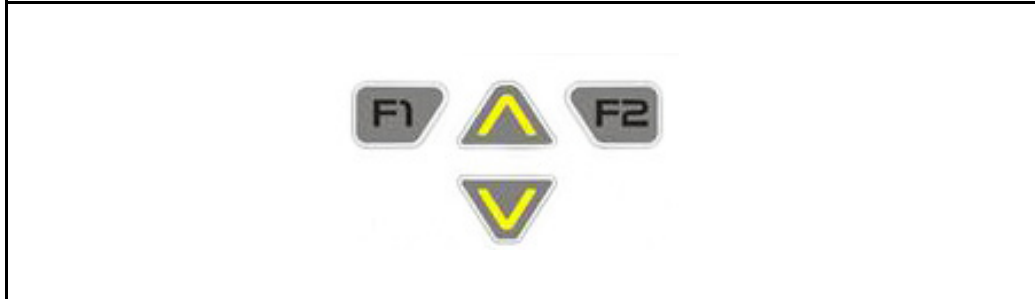

Key Programming.



All 4 keys enabled



All 4 keys disabled



Enable a combination of the 4 keys

To configure this feature, scan the ENTER/EXIT PROGRAMMING MODE bar code above, then the bar code at left followed by 4 digits from the Alphanumeric characters in [Appendix D, Keypad](#).

The last 3 digits must always be 0; the 4 bits of the first digit must be 1 if the corresponding key is enabled; the four bits represent, starting from the highest: Arrow Up, F2, F1, Arrow Down. End by scanning the ENTER/EXIT bar code again.

Make a mistake? Scan the CANCEL bar code to abort and not save the entry string. You can then start again at the beginning.



CANCEL



CONFIGURE ACTIONS FOR FUNCTION KEYS

Each of the function keys can be programmed to perform a user-assigned function. This is done by associating a function key with either a predefined command or your own custom string. See the "Define Strings" on page 251 command to define customized strings.

Each function key has an associated label which shows in the display when active. The default labels are shown in the table below. To program the function key labels, see "Set String ID" on page 252.

The following table shows the list of predefined commands and available strings.

Table 26. Keyboard Programming

CMD_ID	Name	Function	Default Label
0	Not configured	No configured action. If a key must be kept enabled but in normal mode isn't required, this function can be selected to keep it inactive. Whenever an unconfigured function key is pressed, an error message appears on display and an error beep is emitted.	<None>
1	Enter CMD	Same as ENTER_KEY.	Ent
2	String 1	Display and transmit string 1.	S1T
3	String 2	Display and transmit string 2.	S2T
4	String 3	Display and transmit string 3.	S3T
5	String 4	Display and transmit string 4.	S4T
6	String 5	Display and transmit string 5.	S5T
7	Backlight CMD	Toggle backlight on/off.	BlT
8	Clear CMD	Clears the screen	CLR
9		Reserved for future use	
A		Reserved for future use	
B	Show Date/Time	Display the internal date, time.	Tim
C		Reserved for future use	



Action Configuration for Function Keys

Configure actions (up to three) for the function keys

Configure Actions for F1

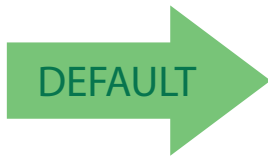

Configures Action for F1



F1 No Actions Configured

To configure this feature, scan the ENTER/EXIT PROGRAMMING MODE bar code above, then the bar code for the Function Key you want to program. Next scan 4 digits from the Alphanumeric characters in [Appendix D, Keypad](#).

The first digit must be 0; the following 3 digits must be configured according to the CMD_ID numbers in [Table 26 on page 249](#). End by scanning the ENTER/EXIT bar code again.

Make a mistake? Scan the CANCEL bar code to abort and not save the entry string. You can then start again at the beginning.



CANCEL

Configure Actions for F2

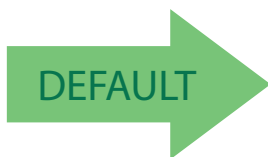

Configure Actions for F2



F2 No Actions Configured

To configure this feature, scan the ENTER/EXIT PROGRAMMING MODE bar code above, then the bar code for the Function Key you want to program. Next scan 4 digits from the Alphanumeric characters in [Appendix D, Keypad](#).

The first digit must be 0; the following 3 digits must be configured according to the CMD_ID numbers in [Table 26 on page 249](#). End by scanning the ENTER/EXIT bar code again.

Make a mistake? Scan the CANCEL bar code to abort and not save the entry string. You can then start again at the beginning.



CANCEL



Define Strings

Configure string 1–5.

To configure this feature, scan the ENTER/EXIT PROGRAMMING MODE bar code at the top of the page, then the bar code for the String you want to set. Define the label string by scanning 32 digits from the Alphanumeric characters in [Appendix D, Keypad](#).

The digits must be the hexadecimal ASCII representation of the desired characters; if less than the expected string of 16 characters are selected, scan the ENTER/EXIT bar code to terminate the string.

End by scanning the ENTER/EXIT bar code again.



Set String 1



Set String 2



Set String 3



Set String 4



Set String 5

Make a mistake? Scan the CANCEL bar code to abort and not save the entry string. You can then start again at the beginning.



CANCEL



Set String ID

Sets the identifier of the predefined strings.



Set String ID

To configure this feature, scan the ENTER/EXIT PROGRAMMING MODE bar code above, then the bar code at left followed by 6 digits from the Alphanumeric characters in [Appendix D, Keypad](#).

The ID characters must be represented by their hexadecimal ASCII code; if the first 2 digits are 0, this feature is disabled. End by scanning the ENTER/EXIT bar code again.

Make a mistake? Scan the CANCEL bar code to abort and not save the entry string. You can then start again at the beginning.



CANCEL

Set String Header

Sets the header of the predefined strings.



Set String Header

To configure this feature, scan the ENTER/EXIT PROGRAMMING MODE bar code above, then the bar code at left followed by 32 digits from the Alphanumeric characters in [Appendix D, Keypad](#).

The digits must be the hexadecimal ASCII representation of the desired characters. If less than the expected string of 16 characters are selected, scan the ENTER/EXIT bar code to terminate the string.

If the first 2 digits are 0, the feature is disabled. End by scanning the ENTER/EXIT bar code again.

Make a mistake? Scan the CANCEL bar code to abort and not save the entry string. You can then start again at the beginning.



CANCEL



Set String Terminator

Sets the terminator of the predefined strings.



Set String Terminator

To configure this feature, scan the ENTER/EXIT PROGRAMMING MODE bar code above, then the bar code at left followed by 32 digits from the Alphanumeric characters in [Appendix D, Keypad](#).

The digits must be the hexadecimal ASCII representation of the desired characters. If less than the expected string of 16 characters are selected, scan the ENTER/EXIT bar code to terminate the string.

If the first 2 digits are 0, the feature is disabled. End by scanning the ENTER/EXIT bar code again.

Make a mistake? Scan the CANCEL bar code to abort and not save the entry string. You can then start again at the beginning.



CANCEL

NOTES



Chapter 4 References

This section contains explanations and examples of selected bar code features. See [Configuration Using Bar Codes](#), starting on page 21 for the actual bar code labels used to configure the reader.

RS-232 PARAMETERS on page 256 <ul style="list-style-type: none">▪ RS-232 Only on page 256▪ RS-232/USB COM Parameters on page 257
KEYBOARD INTERFACE on page 264 <ul style="list-style-type: none">▪ Wedge Quiet Interval on page 264▪ Intercharacter Delay on page 265▪ Intercode Delay on page 266
SYMBOLOGIES on page 267 <ul style="list-style-type: none">▪ Datamatrix DPM Decoding Safety on page 267▪ Set Length on page 267
DATA EDITING on page 269 <ul style="list-style-type: none">▪ Global Prefix/Suffix on page 270▪ Global AIM ID on page 270▪ Label ID on page 272▪ Character Conversion on page 277
READING PARAMETERS on page 278 <ul style="list-style-type: none">▪ Good Read LED Duration on page 278
SCANNING FEATURES on page 279 <ul style="list-style-type: none">▪ Scan Mode on page 279▪ Stand Mode Off Time on page 280▪ Scanning Active Time on page 281▪ Aiming Duration Time on page 282▪ Flash On Time on page 283▪ Flash Off Time on page 284▪ Multiple Labels Ordering by Code Symbology on page 285
WIRELESS FEATURES starting on page 288 <ul style="list-style-type: none">▪ Automatic Configuration Update▪ RF Address Stamping▪ RF Address Stamping▪ PM9500-Only Features▪ Bluetooth-Only Features
MOTION FEATURES on page 287 <ul style="list-style-type: none">▪ Motionless Timeout on page 287

RS-232 Parameters

RS-232 Only

Baud Rate

Baud rate is the number of bits of data transmitted per second. Set the reader's baud rate to match the baud rate setting of the host device. With an improper baud rate setting, data may not reach the host correctly.

Stop Bits

The stop bit(s) at the end of each transmitted character marks the end of transmission of one character and prepares the receiving device for the next character in the serial data stream. The number of stop bits selected (one or two) depends on the number the receiving terminal is programmed to accommodate. Set the number of stop bits to match host device requirements.

Parity

This feature specifies parity required for sending and receiving data. A parity check bit is the most significant bit of each ASCII coded character. Select the parity type according to host device requirements.

- Select None when no parity bit is required.
- Select Odd parity and the parity bit value is set to 0 or 1, based on data, to ensure that an odd number of 1 bits are contained in the coded character.
- Select Even parity and the parity bit value is set to 0 or 1, based on data, to ensure that an even number of 1 bits are contained in the coded character.

Handshaking Control

The data interface consists of an RS-232 port designed to operate either with or without the hardware handshaking lines, *Request to Send* (RTS), and *Clear to Send* (CTS). Handshaking Control includes the following options:

- RTS — RTS is asserted during transmissions. CTS is ignored.
- RTS/CTS — RTS is asserted during transmissions. CTS gates transmissions.
- RTS/XON/XOFF — RTS is asserted during transmissions. CTS is ignored. XON and XOFF gate transmissions.
- RTS On/CTS — RTS is always asserted. CTS gates transmissions.

RTS/CTS Scan Control — RTS is asserted during transmissions. CTS gates transmissions and controls enable and disable state of scanner.

RS-232/USB COM Parameters

Intercharacter Delay

This parameter specifies the intercharacter delay between the end of one character and the beginning of the next. The delay can be set within a range of zero (0) to 990 milliseconds in 10ms increments. A setting of zero specifies no delay.

To set the delay:

1. Determine the desired setting in milliseconds.
2. Divide the desired setting by 10 (setting is in 10ms increments). Pad the result with leading zeroes to yield two digits. For example: 0 = 00, 5 = 05, 20 = 20, etc.
3. Scan the ENTER/EXIT PROGRAMMING MODE bar code to enter Programming Mode.
4. Go to [page 31](#) and scan the bar code: SELECT INTERCHARACTER DELAY SETTING.
5. Scan the appropriate two digits from the keypad in [Appendix D, Keypad](#), that represent the duration which was determined in the steps above. You will hear a two-beep indication after the last character.



If you make a mistake before the last character, scan the CANCEL bar code to abort and not save the entry string. You can then start again at the beginning.

6. Scan the ENTER/EXIT PROGRAMMING MODE bar code to exit.

This completes the procedure. See [Table 27](#) for some examples of how to set this feature.

Table 27. Intercharacter Delay Setting Examples

STEP	ACTION	EXAMPLES			
1	Desired Setting	50ms	150ms	600ms	850ms
2	Divide by 10 (pad with leading zeroes to yield two-digits)	05	15	60	85
3	Scan ENTER/EXIT PROGRAMMING MODE				
4	Scan SELECT INTERCHARACTER DELAY SETTING				
5	Scan Two Characters From Appendix D, Keypad	'0' and '5'	'5' and '0'	'6' and '0'	'8' and '5'
6	Scan ENTER/EXIT PROGRAMMING MODE				

ACK NAK Options

This enables/disables the ability of the reader to support the RS-232 ACK/NAK protocol. When configured, the reader and/or host sends an “ACK” when it receives data properly, and sends “NAK” when the data is in error.

Options are:

- Disable
- Enable for label transmission — The reader expects an ACK/NAK response from the host when a label is sent.
- Enable for host-command acknowledge — The reader will respond with ACK/NAK when the host sends a command.
- Enable for label transmission and host-command acknowledge

ACK Character

This setting specifies an ASCII character or hex value to be used as the ACK character. ASCII characters or any hex value from 0 to 0xFF can be selected.



Setting to previously defined characters such as XON, XOFF, or host commands conflicts with normal operation of these characters. 8-bit data is not recognized when the option **Data Bits** has been set as 7 Data Bits.

1. Determine the desired character or value.
 2. Use the [ASCII Chart](#) on the inside back cover of this manual to find the hex equivalent for the desired character/value.
 3. Go to [page 33](#) and scan ENTER/EXIT PROGRAMMING MODE to enter Programming Mode.
 4. Scan the bar code: SELECT ACK CHARACTER SETTING.
 5. Scan the appropriate two alphanumeric characters from the keypad in [Appendix D, Keypad](#), that represent the desired character/value in step 1 above. The second character will cause a two-beep indication.
 6. Scan the ENTER/EXIT PROGRAMMING MODE bar code to exit.
- See [Table 28](#) for some examples of how to set this feature.

Table 28. ACK Character Setting Examples

STEP	ACTION	EXAMPLES			
1	Desired Character/Value	ACK	\$	@	>
2	Hex equivalent from ASCII Chart	0x06	0x24	0x40	0x3E
3	Scan ENTER/EXIT PROGRAMMING MODE				
4	Scan SELECT ACK CHARACTER SETTING				
5	Scan Two Characters from Appendix D, Keypad	'0' and '6'	'2' and '4'	'4' and '0'	'3' AND 'E'
6	Scan ENTER/EXIT PROGRAMMING MODE				

NAK Character

This setting specifies an ASCII character or hex value to be used as the NAK character. ASCII characters or any hex value from 0 to 0xFF can be selected.



Setting to previously defined characters such as XON, XOFF, or host commands conflicts with normal operation of these characters. 8-bit data is not recognized when the option [Data Bits](#) has been set as 7 Data Bits.

To set this feature:

1. Determine the desired character or value.
2. Use the [ASCII Chart](#) on the inside back cover of this manual to find the hex equivalent for the desired character/value.
3. Go to [page 33](#) and scan the ENTER/EXIT PROGRAMMING MODE bar code to enter Programming Mode.
4. Scan the bar code: SELECT NAK CHARACTER SETTING.
5. Scan the appropriate two alphanumeric characters from the keypad in [Appendix D, Keypad](#), that represent the desired character/value in step 1 above. The second character will cause a two-beep indication.
6. Scan the ENTER/EXIT PROGRAMMING MODE bar code to exit Programming Mode.

This completes the procedure. See [Table 29](#) for some examples of how to set this feature.

Table 29. NAK Character Setting Examples

STEP	ACTION	EXAMPLES			
1	Desired Character/Value	NAK	\$	@	>
2	Hex equivalent from ASCII Chart	0x15	0x24	0x40	0x3E
3	Scan ENTER/EXIT PROGRAMMING MODE				
4	Scan SELECT NAK CHARACTER SETTING				
5	Scan Two Characters From Appendix D, Keypad	'1' and '5'	'2' and '4'	'4' and '0'	'3' AND 'E'
6	Scan ENTER/EXIT PROGRAMMING MODE				

ACK NAK Timeout Value

This option specifies the amount of time the reader waits for an ACK character from the host following label transmission. The selectable timeout range is 200 milliseconds to 15,000ms (15 seconds) in 200ms increments. A selection of 0 disables the timeout.

To set this value:

1. Determine the desired setting in milliseconds.
2. Divide the desired setting by 200 (setting is in 200ms increments). Pad the result with leading zeroes to yield two digits. For example: 0 = 00, 5 = 05, 20 = 20, etc.
3. Go to [page 34](#) and scan the ENTER/EXIT PROGRAMMING MODE bar code to enter Programming Mode.
4. Scan the bar code: SELECT ACK NAK TIMEOUT VALUE SETTING.
5. Scan the appropriate two digits from the keypad in [Appendix D, Keypad](#), that represent the duration which was determined in the steps above. You will hear a two-beep indication after the last character.



If you make a mistake before the last character, scan the CANCEL bar code to abort and not save the entry string. You can then start again at the beginning.

6. Scan the ENTER/EXIT PROGRAMMING MODE bar code to exit Programming Mode.

This completes the procedure. See [Table 30](#) for some examples of how to set this feature.

Table 30. ACK NAK Timeout Value Setting Examples

STEP	ACTION	EXAMPLES			
1	Desired Setting	200ms	1,000ms (1 sec.)	5200ms (5.2 sec.)	15,000ms (15 sec.)
2	Divide by 200	01	05	26	75
3	Scan ENTER/EXIT PROGRAMMING MODE				
4	Scan SELECT ACK NAK TIMEOUT VALUE SETTING				
5	Scan Two Characters From Appendix D, Keypad	'0' and '1'	'0' and '5'	'2' and '6'	'7' and '5'
6	Scan ENTER/EXIT PROGRAMMING MODE				

ACK NAK Retry Count

This feature specifies the number of times the reader retries a label transmission due to a retry condition. The selectable range is from 1 to 254 retries. A selection of 0 disables the count, and a selection of 255 specifies unlimited retries.

To set this feature:

1. Determine the desired setting.
2. Pad the number with leading zeroes to yield three digits. For example: 0 = 000, 5 = 005, 20 = 020, etc.
3. Go to [page 34](#) and scan the ENTER/EXIT PROGRAMMING MODE bar code to enter Programming Mode.
4. Scan the bar code: SELECT ACK NAK RETRY COUNT SETTING.
5. Scan the appropriate three digits from the keypad in [Appendix D, Keypad](#), that represent the number which was determined in the steps above. You will hear a two-beep indication after the last character.



If you make a mistake before the last character, scan the CANCEL bar code to abort and not save the entry string. You can then start again at the beginning.

6. Scan the ENTER/EXIT PROGRAMMING MODE bar code to exit Programming Mode.

This completes the procedure. See [Table 31](#) for some examples of how to set this feature.

Table 31. ACK NAK Retry Count Setting Examples

STEP	ACTION	EXAMPLES			
1	Desired Setting	Disable Retry Count	3 Retries	54 Retries	Unlimited Retries
2	Pad with leading zero(es)	000	003	054	255
3	Scan ENTER/EXIT PROGRAMMING MODE				
4	Scan SELECT ACK NAK RETRY COUNT SETTING				
5	Scan Three Characters From Appendix D, Keypad	'0', '0' and '0'	'0', '0' and '3'	'0', '5' and '4'	'2', '5' and '5'
6	Scan ENTER/EXIT PROGRAMMING MODE				

Disable Character

Specifies the value of the RS-232 host command used to disable the reader. ASCII characters or any hex value from 0 to 0xFF can be selected.



Setting to previously defined characters such as XON, XOFF, or host commands conflicts with normal operation of these characters. 8-bit data is not recognized when the option [Data Bits](#) has been set as 7 Data Bits.

To set the value:

1. Determine the desired character or value. A setting of 0xFF indicates the Disable Character is not used (not available).
2. Use the [ASCII Chart](#) on the inside back cover of this manual to find the hex equivalent for the desired character/value.
3. Go to [page 36](#) and scan the ENTER/EXIT PROGRAMMING MODE bar code to enter Programming Mode.
4. Scan the bar code: SELECT DISABLE CHARACTER SETTING.
5. Scan the appropriate two alphanumeric characters from the keypad in [Appendix D, Keypad](#), that represent the desired character/value in step 1 above. The second character will cause a two-beep indication.
6. Scan the ENTER/EXIT PROGRAMMING MODE bar code to exit Programming Mode.

This completes the procedure. See [Table 32](#) for some examples of how to set this feature.

Table 32. Disable Character Setting Examples

STEP	ACTION	EXAMPLES			
1	Desired character/value	'd'	'}'	'D'	Disable Command Not Used
2	Hex equivalent from ASCII Chart	0x64	0x7D	0x44	0xFF
3	Scan ENTER/EXIT PROGRAMMING MODE				
4	Scan SELECT DISABLE CHARACTER VALUE SETTING				
5	Scan Two Characters From Appendix D, Keypad	'6' and '4'	'7' and 'D'	'4' and '4'	'F' AND 'F'
6	Scan ENTER/EXIT PROGRAMMING MODE				

Enable Character

Specifies the value of the RS-232 host command used to enable the reader. ASCII characters or any hex value from 0 to 0xFF can be selected.



Setting to previously defined characters such as XON, XOFF, or host commands conflicts with normal operation of these characters. 8-bit data is not recognized when the option **Data Bits** has been set as 7 Data Bits.

To set this feature:

Determine the desired character or value. A setting of 0xFF indicates the Enable Character is not used (not available).

1. Determine the desired character or value.
2. Use the [ASCII Chart](#) on the inside back cover of this manual to find the hex equivalent for the desired character/value.
3. Go to [page 36](#) and scan the ENTER/EXIT PROGRAMMING MODE bar code to enter Programming Mode.
4. Scan the bar code: SELECT ENABLE CHARACTER SETTING.
5. Scan the appropriate two alphanumeric characters from the keypad in [Appendix D, Keypad](#), that represent the desired character/value in step 2 above. The second character will cause a two-beep indication.
6. Scan the ENTER/EXIT PROGRAMMING MODE bar code to exit Programming Mode.

This completes the procedure. See [Table 33](#) for some examples of how to set this feature.

Table 33. Enable Character Setting Examples

STEP	ACTION	EXAMPLES			
1	Desired character/value	'e'	'}'	'E'	Enable Command Not Used
2	Hex equivalent from ASCII Chart	0x65	0x7D	0x45	0xFF
3	Scan ENTER/EXIT PROGRAMMING MODE				
4	Scan SELECT ENABLE CHARACTER VALUE SETTING				
5	Scan Two Characters From Appendix D, Keypad	'6' and '5'	'7' and 'D'	'4' and '5'	'F' AND 'F'
6	Scan ENTER/EXIT PROGRAMMING MODE				

Keyboard Interface

Wedge Quiet Interval

Specifies the amount of time the reader looks for keyboard activity before it breaks the keyboard connection in order to transmit data to host. The range is from 0 to 990ms in 10ms increments.



This feature applies **ONLY** to the Keyboard Wedge interface.

1. Determine the desired setting in milliseconds.
2. Divide the desired setting by 10 (setting is in 10ms increments). Pad the result with leading zeroes to yield two digits. For example: 0 = 00, 5 = 05, 20 = 20, etc.
3. Go to [page 42](#) and scan the ENTER/EXIT PROGRAMMING MODE bar code to enter Prog. Mode.
4. Scan the bar code: SELECT WEDGE QUIET INTERVAL SETTING.
5. Scan the appropriate two digits from the keypad in [Appendix D, Keypad](#), that represent the duration which was determined in the steps above. You will hear a two-beep indication after the last character.



If you make a mistake before the last character, scan the CANCEL bar code to abort and not save the entry string. You can then start again at the beginning.

6. Scan the ENTER/EXIT PROGRAMMING MODE bar code to exit.

This completes the procedure to set the Wedge Quiet Interval. See [Table 34](#) for some examples of how to set this feature.

Table 34. Wedge Quiet Interval Setting Examples

STEP	ACTION	EXAMPLES			
1	Desired Setting	10ms	150ms	600ms	850ms
2	Divide by 10 (and pad with leading zeroes)	01	15	60	85
3	Scan ENTER/EXIT PROGRAMMING MODE				
4	Scan SELECT WEDGE QUIET INTERVAL SETTING				
5	Scan Two Characters From Appendix D, Keypad	'0' and '1'	'1' and '5'	'6' and '0'	'8' and '5'
6	Scan ENTER/EXIT PROGRAMMING MODE				

Intercharacter Delay

This parameter specifies the intercharacter delay between the end of one character and the beginning of the next. The delay can be set within a range of zero (0) to 990 milliseconds in 10ms increments. A setting of zero specifies no delay.



This feature applies **ONLY** to the Keyboard Wedge interface.

To set the delay:

1. Determine the desired setting in milliseconds.
2. Divide the desired setting by 10 (setting is in 10ms increments). Pad the result with leading zeroes to yield two digits. For example: 0 = 00, 5 = 05, 20 = 20, etc.
3. Go to [page 31](#) and scan the ENTER/EXIT PROGRAMMING MODE bar code to enter Programming Mode.
4. Scan the bar code: SELECT INTERCHARACTER DELAY SETTING.
5. Scan the appropriate two digits from the keypad in [Appendix D, Keypad](#), that represent the duration which was determined in the steps above. You will hear a two-beep indication after the last character.



If you make a mistake before the last character, scan the CANCEL bar code to abort and not save the entry string. You can then start again at the beginning.

6. Scan the ENTER/EXIT PROGRAMMING MODE bar code to exit Programming Mode.

This completes the procedure. See [Table 35](#) for some examples of how to set this feature.

Table 35. Intercharacter Delay Setting Examples

STEP	ACTION	EXAMPLES			
1	Desired Setting	50ms	150ms	600ms	850ms
2	Divide by 10 (and pad with leading zeroes to yield two-digits)	05	15	60	85
3	Scan ENTER/EXIT PROGRAMMING MODE				
4	Scan SELECT INTERCHARACTER DELAY SETTING				
5	Scan Two Characters From Appendix D, Keypad	'0' and '5'	'1' and '5'	'6' and '0'	'8' and '5'
6	Scan ENTER/EXIT PROGRAMMING MODE				

Intercode Delay

Specifies the delay between labels transmitted to the host for this interface. The selectable range for this feature is from 0 to 99 seconds.

Follow these instructions to set this feature:

1. Determine the desired setting.
2. Pad the number with leading zeroes to yield two digits. For example: 0 = 00, 5 = 05, 20 = 20, etc
3. Go to [page 42](#) and scan the ENTER/EXIT PROGRAMMING MODE bar code to enter Programming Mode.
4. Scan the bar code: SELECT INTERCODE DELAY SETTING.
5. Scan the appropriate two digits from the keypad in [Appendix D, Keypad](#), that represent the duration which was determined in the steps above. You will hear a two-beep indication after the last character.



If you make a mistake before the last character, scan the CANCEL bar code to abort and not save the entry string. You can then start again at the beginning.

6. Scan the ENTER/EXIT PROGRAMMING MODE bar code to exit Programming Mode.

This completes the procedure. See [Table 36](#) for some examples of how to set this feature.

Table 36. Wedge Intercode Delay Examples

STEP	ACTION	EXAMPLES			
1	Desired Setting	No Delay	5 Seconds	60 Seconds	99 Seconds
2	Pad with leading zero(es)	00	05	60	99
3	Scan ENTER/EXIT PROGRAMMING MODE				
4	Scan SELECT INTERCODE DELAY SETTING				
5	Scan Two Characters From Appendix D, Keypad	'0' and '0'	'0' and '5'	'6' and '0'	'9' AND '9'
6	Scan ENTER/EXIT PROGRAMMING MODE				

Symbologies

Datamatrix DPM Decoding Safety

Decoding Safety is used to configure a decoder to be very aggressive to very conservative, depending on a particular customer's needs.

- Level 1 results in a very aggressive decoder.
- Level 5 results in a very conservative decoder at the expense of not being able to read poorly printed or damaged labels.

There are many factors that determine when to change the decoding safety. These factors include spots, voids, non-uniform backgrounds, damaged labels, etc. that may be experienced in some barcode labels. If there are many hard to read or damaged labels that cannot be decoded using a conservative setting, decrease the decoding safety to be more aggressive. In case of rigorous reliability application requirements it is suggested to use higher decoding safety values (conservative).

Set Length

Length Control allows you to select either variable length decoding or fixed length decoding for the specified symbology.

Variable Length: For variable length decoding, a minimum and maximum length may be set.

Fixed Length: For fixed length decoding, two different lengths may be set.

Set Length 1

This feature specifies one of the bar code lengths for Length Control. Length 1 is the minimum label length if in Variable Length Mode, or the first fixed length if in Fixed Length Mode. Length includes the bar code's data characters only.

The number of characters that can be set varies, depending on the symbology. Reference the page for your selected symbology to see specific variables.

1. Determine the desired character length (varies depending on symbology). Pad the number with leading zeroes to yield two digits. For example: 0 = 00, 5 = 05, 20 = 20, etc.
2. Go to the Set Length page for your selected symbology and scan the ENTER/EXIT PROGRAMMING MODE bar code to enter Programming Mode.
3. Scan the bar code to SELECT LENGTH 1 SETTING for your selected symbology.
4. Scan the appropriate two digits from the keypad in [Appendix D, Keypad](#), that represent the length setting which was determined in the steps above. You will hear a two-beep indication after the last character.



If you make a mistake before the last character, scan the CANCEL bar code to abort and not save the entry string. You can then start again at the beginning.

5. Scan the ENTER/EXIT PROGRAMMING MODE bar code to exit Prog Mode.

Set Length 2

This feature allows you to set one of the bar code lengths for the specified symbology. Length 2 is the maximum label length if in [Variable Length Mode](#), or the second fixed length if in [Fixed Length Mode](#). See the page for the specific symbology for parameters.

The length that can be set varies depending on the symbology. A setting of 0 specifies to ignore this length (only one fixed length).

Follow these instructions to set this feature:

1. Determine the desired character length (from 1 to 50 — or 0 to ignore this length). Pad the number with leading zeroes to yield two digits. For example: 0 = 00, 5 = 05, 20 = 20, etc.
2. Go to the Set Length page for your selected symbology and scan the ENTER/EXIT PROGRAMMING MODE bar code to enter Programming Mode.
3. Scan the bar code to SELECT LENGTH 2 SETTING for your selected symbology.
4. Scan the appropriate two digits from the keypad in [Appendix D, Keypad](#) that represent the length setting which was determined in the steps above. You will hear a two-beep indication after the last character.



If you make a mistake, before the last character scan the CANCEL bar code to abort and not save the entry string. You can then start again at the beginning.

5. Scan the ENTER/EXIT PROGRAMMING MODE bar code to exit Programming Mode.

This completes the procedure.

Data Editing



CAUTION

It is not recommended to use these features with IBM interfaces.

When a bar code is scanned, additional information can be sent to the host computer along with the bar code data. This combination of bar code data and supplementary user-defined data is called a “message string.” The Data Editing features can be used to build specific user-defined data into a message string.

There are several types of selectable data characters that can be sent before and after scanned data. You can specify if they should be sent with all symbologies, or only with specific symbologies. Figure 7 shows the available elements you can add to a message string:

Figure 7. Breakdown of a Message String

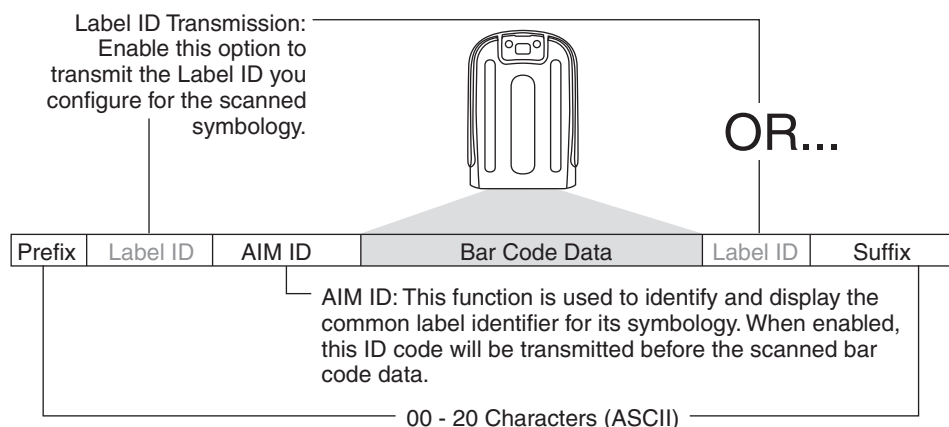

Additional advanced editing is available. See the Advanced formatting features in the Datalogic Aladdin configuration software, or contact Technical Support (as described on [page 2](#)) for more information.

Please Keep In Mind...

- Modifying a message string is not a mandatory requirement. Data editing is a sophisticated feature allowing highly customizable output for advanced users. Factory default settings for data editing is typically set to NONE.
- A prefix or suffix may be applied only to a specified symbology (reference [1D Symbologies, starting on page 81](#) or [2D Symbologies, starting on page 173](#)) or across all symbologies (set via the Global features in this chapter).
- You can add any character from the [ASCII Chart](#) (from 00–FF) on the inside back cover of this manual as a prefix, suffix or Label ID.
- Enter prefixes and suffixes in the order in which you want them to appear on the output.

Global Prefix/Suffix

Up to 20 ASCII characters may be added as a prefix (in a position before the bar code data) and/or as a suffix (in a position following the bar code data) as indicated in Figure 8.

Figure 8. Prefix and Suffix Positions

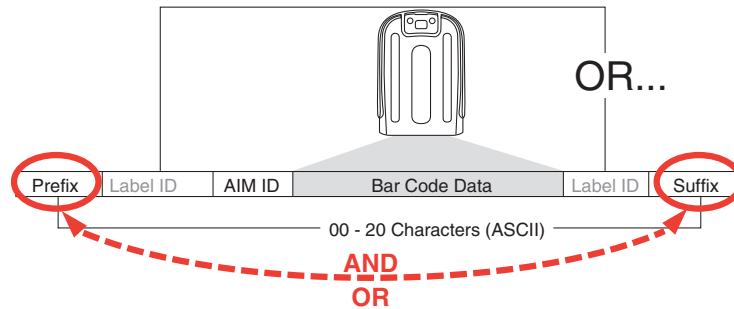

Example: Setting a Prefix

In this example, we'll set a prefix for all symbologies.

1. Determine which ASCII character(s) are to be added to scanned bar code data. In this example, we'll add a dollar sign ('\$') as a prefix.
2. Go to [page 50](#) and scan the ENTER/EXIT PROGRAMMING MODE bar code, then scan the SET GLOBAL PREFIX bar code.
3. Reference the [ASCII Chart](#) on the inside back cover of this manual to find the hex value assigned to the desired character. The corresponding hex number for the '\$' character is 24. To enter this selection code, scan the '2' and '4' bar codes from [Appendix D, Keypad](#).



If you make a mistake before the last character, scan the CANCEL bar code to abort and not save the entry string. You can then start again at the beginning.

4. If less than the expected string of 20 characters are selected, scan the ENTER/EXIT bar code to terminate the string.
5. Scan the ENTER/EXIT bar code once again to exit Programming Mode.
6. The resulting message string would appear as follows:
Scanned bar code data: 12345
Resulting message string output: \$12345

Global AIM ID



This feature enables/disables addition of AIM IDs for all symbology types.

AIM label identifiers (as opposed to custom characters you select yourself as with label identifiers) can be included with scanned bar code data. AIM label identifiers consist of three characters as follows:

- A close brace character (ASCII '['), followed by...
- A code character (see the table below), followed by...

- A modifier character (the modifier character is symbol dependent).

SYMBOLGY	CHAR	SYMBOLGY	CHAR
UPC/EAN	E ^a	Code 128/GS1-128	C
Code 39 and Code 32	A	DataBar Omnidirectional, DataBar Expanded	e
Codabar	F	Standard 2 of 5	S
Interleaved 2 of 5	I	ISBN	X ^b
Code 93	G	Code 11	H

- UPC-A and UPC-E labels are converted to EAN 13 when adding AIM IDs.
- ISBN (X with a 0 modifier character)

Figure 9. AIM ID

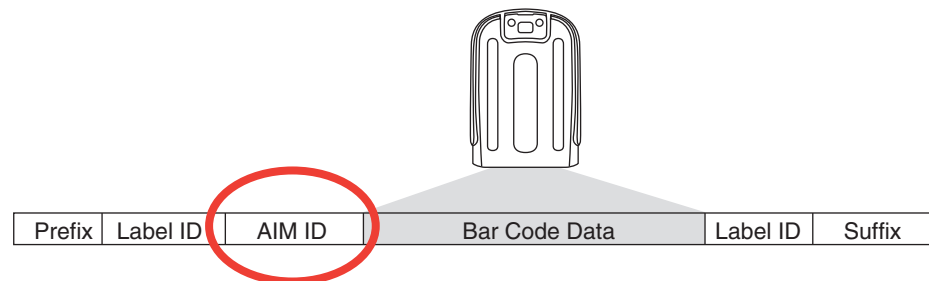

Label ID

A Label ID is a customizable code of up to three ASCII characters (each can be one of hex 0x01–0xFF), used to identify a bar code (symbology) type. It can be appended previous to or following the transmitted bar code data depending upon how this option is enabled. This feature provides options for configuring custom Label IDs as a pre-loaded set (see "Label ID: Pre-loaded Sets" below) or individually per symbology (see "Label ID: Set Individually Per Symbology" on page 275). If you wish to program the reader to always include an industry standard label identifier for ALL symbology types, see "Global AIM ID" on page 51.

Label ID: Pre-loaded Sets

The reader supports two pre-loaded sets of Label IDs. Table 37 shows the USA and the EU sets.



When changing from one Label ID set to another, all other reader configuration settings, including the host interface type, will be erased and set to the standard factory defaults. Any custom configuration or custom defaults will be lost.

Table 37. Label ID Pre-loaded Sets

Symbology	USA Label ID set		EU Label ID set	
	Default Character	Default ASCII	Default Character	Default ASCII
ABC CODABAR	S	530000	S	530000
ANKER PLESSEY	o	6F0000	o	6F0000
AZTEC	Az	417A00	!	210000
CHINA SENSIBLE CODE	\$S	245300	\$S	245300
CODABAR	%	250000	R	520000
CODE11	CE	434500	b	620000
CODE128	#	230000	T	540000
CODE32	A	410000	X	580000
CODE39	*	2A0000	V	560000
CODE39 CIP	Y	590000	Y	590000
CODE39 DANISH PPT	\$Y	245900	\$Y	245900
CODE39 LAPOSTE	\$a	246100	\$a	246100
CODE39 PZN	\$Z	245A00	\$Z	245A00
CODE93	&	260000	U	550000
DATABAR 14	R4	523400	u	750000
DATABAR 14 COMPOSITE	R4	523400	c	523400
DATABAR EXPANDED	RX	525800	t	740000

Symbology	USA Label ID set		EU Label ID set	
	Default Character	Default ASCII	Default Character	Default ASCII
DATABAR EXPANDED COMPOSITE	RX	525800	d	525800
DATABAR LIMITED	RL	524C00	v	760000
DATABAR LIMITED COMPOSITE	RL	524C00	i	524C00
DATA MATRIX	Dm	446D00	w	770000
EAN128		000000	k	6B0000
EAN128 COMPOSITE		000000	\$E	244500
EAN13	F	460000	B	420000
EAN13 P2	F	460000	L	4C0000
EAN13 P5	F	460000	M	4D0000
EAN13 COMPOSITE	F	460000	\$F	244600
EAN8	FF	464600	A	410000
EAN8 P2	FF	464600	J	4A0000
EAN8 P5	FF	464600	K	4B0000
EAN8 COMPOSITE	FF	464600	\$G	244700
FOLLET 20F5	O	4F0000	O	4F0000
GTIN	G	470000	\$A	244100
GTIN2	G2	473200	\$B	244200
GTIN5	G5	473500	\$C	244300
I20F5	i	690000	N	4E0000
IATA INDUSTRIAL 20F5	IA	494100	&	260000
INDUSTRIAL 20F5	W	570000	W	570000
ISBN	I	490000	@	400000
ISBT128 CONCAT	f	660000	f	660000
ISSN	n	6E0000	n	6E0000
MAXICODE	MC	4D4300	x	780000
MICRO QR	\$Q	245100	\$Q	245100
MICRO PDF	mP	6D5000	8	380000
MSI	@	400000	Z	5A0000
PDF417	P	500000	r	720000
PLESSEY	a	610000	a	610000
POSTAL AUSTRALIAN	\$K	244B00	\$K	244B00
POSTAL IMB	\$V	245600	\$V	245600

References

Symbology	USA Label ID set		EU Label ID set	
	Default Character	Default ASCII	Default Character	Default ASCII
POSTAL JAPANESE	\$R	245200	\$R	245200
POSTAL KIX	\$U	245500	\$U	245500
POSTAL PLANET	\$W	245700	\$W	245700
POSTAL PORTUGAL	\$P	245000	\$P	245000
POSTAL POSTNET BB	\$L	244C00	\$L	244C00
POSTAL ROYAL MAIL	\$M	244D00	\$M	244D00
POSTAL SWEDISH	\$X	245800	\$X	245800
POSTNET	1	310000	1	310000
QR CODE	QR	515200	y	790000
S25	s	730000	P	500000
TRIOPTIC	\$T	245400	\$T	245400
UPCA	A	410000	C	430000
UPCA P2	A	410000	F	460000
UPCA P5	A	410000	G	470000
UPCA COMPOSITE	A	410000	\$H	244800
UPCE	E	450000	D	440000
UPCE P2	E	450000	H	480000
UPCE P5	E	450000	I	490000
UPCE COMPOSITE	E	450000	\$J	244A00

Label ID: Set Individually Per Symbology

To configure a Label ID individually for a single symbology:

1. Go to [page 56](#) and scan the ENTER/EXIT bar code.
2. Select Label ID position as either BEFORE (Enable as Prefix) or AFTER (Enable as suffix) by scanning the appropriate bar code in the section "Label ID Control" on page 56. Reference Figure 10 for Label ID positioning options if multiple identification features are enabled.
3. Scan a bar code to select the symbology for which you wish to configure a custom Label ID from the section "Label ID Symbology Selection – 1D Symbologies" on page 57.
4. Determine the desired character(s) (you may choose up to three) which will represent the Label ID for the selected symbology.
5. Turn to the [ASCII Chart](#) on the inside back cover of this manual and find the equivalent hex digits associated with your choice of Label ID. For example, if you wish to select an equal sign (=) as a Label ID, the chart indicates its associated hex characters as 3D. Turn to [Keypad, starting on page 323](#) and scan the bar codes representing the hex characters determined. For the example given, the characters '3' and 'D' would be scanned. More examples of Label ID settings are provided in [Table 38](#).



If you make a mistake before the last character, scan the CANCEL bar code to abort and not save the entry string. You can then start again at the beginning.

6. Scan the ENTER/EXIT bar code to exit Label ID entry.
 7. Scan the ENTER/EXIT bar code once again to exit Programming Mode.
- This completes the steps to configure a Label ID for a given symbology.

Figure 10. Label ID Position Options

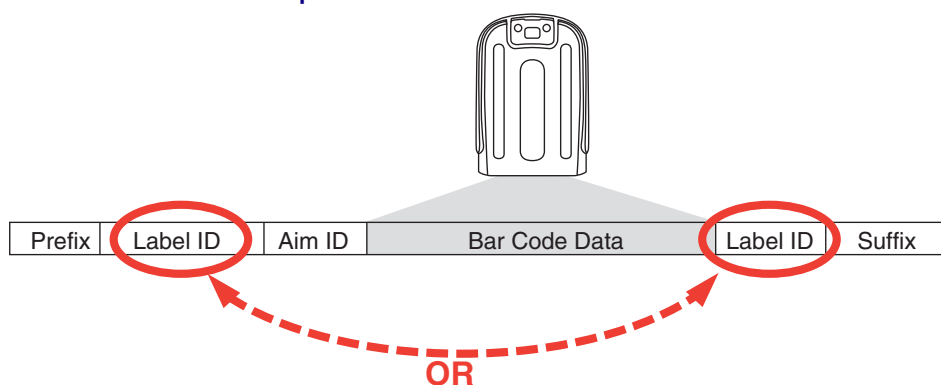

Table 38. Label ID Examples

STEP	ACTION	EXAMPLES			
1.	Scan the ENTER/EXIT bar code	(Scanner enters Programming Mode)			
2.	Determine placement of the Label ID characters BEFORE or AFTER with regard to scanned data using Label ID Control, starting on page 56	Enable as Prefix	Enable as Suffix	Enable as Prefix	Enable as Suffix
3.	Scan the bar code selecting the symbology type you wish to designate label ID characters for using Label ID Symbology Selection – 1D Symbologies, starting on page 57.	DataBar Omnidirectional	Code 39	Interleaved 2 of 5	Code 32
4.	Custom Label ID example (desired characters):	D B *	= C 3	+	P H
5.	Find hex equivalents from the ASCII Chart (inside back cover), then scan in these digits/characters using the bar codes in the section: Keypad, starting on page 323. If you make a mistake before the last character, scan the CANCEL bar code to abort and not save the entry string. You can then start again at the beginning.	44 42 2A	3D 43 33	2B	50 48
6.	Scan the ENTER/EXIT bar code	(Scanner exits Label ID entry)			
7.	Scan the ENTER/EXIT bar code once again	(Scanner exits Programming Mode)			
Result:		DB*[bar code data]	[bar code data]=C3	+ [bar code data]	[bar code data]PH

Character Conversion

Character conversion is an eight byte configuration item. The eight bytes are 4 character pairs represented in hexadecimal ASCII values. The first character in the pair is the character that will be converted. The second character in the pair is the character to convert to. If the character to convert in a pair is FF, then no conversion is done.

For example, if you have the character conversion configuration item set to the following: 41423132FFFFFFFF

The first pair is 4142 or AB (41 hex is an ASCII capital A, 42 hex is an ASCII capital B) and the second pair is 3132 or 12 (31 hex is an ASCII 1, 32 is an ASCII 2). The other two pairs are FFFF and FFFF.

With the label, AB12BA21, it would look as follows after the character conversion: BB22BB22.

The A characters were converted to B characters and the 1 characters were converted to 2 characters. Nothing is done with the last two character pairs, since they are all FF.

To set Character Conversion:

1. Go to [page 61](#) and scan the ENTER/EXIT bar code.
2. Scan the “Configure Character Conversion” bar code.
3. Determine the desired string. Sixteen positions must be determined as in the above example. Next, turn to the [ASCII Chart](#) on the inside back cover of this manual and find the equivalent hex digits needed to fulfill the string.
4. Turn to [Appendix D, Keypad](#) and scan the bar codes representing the hex characters determined in the previous step.
5. Scan the ENTER/EXIT bar code to exit Programming Mode.



If less than the expected string of 16 characters are selected, scan the ENTER/EXIT bar code twice to accept the selections and exit Programming Mode.

Reading Parameters

Good Read LED Duration

This feature specifies the amount of time that the Good Read LED remains on following a good read. The good read LED on time can be set within a range of 10 milliseconds to 2,550 milliseconds (0.001 to 2.55 seconds) in 100ms increments.

Follow these instructions to set this feature:

1. Determine the desired setting in milliseconds. A setting of 0 means that the good read LED stays on until the next time the trigger is pulled.
2. Divide the desired setting by 10 (setting is in 100ms increments). Pad the result with leading zeroes to yield three digits. For example: 0 = 000, 5 = 000, 20 = 020, etc.
3. Go to [page 70](#) and scan the ENTER/EXIT PROGRAMMING MODE bar code to enter Programming Mode.
4. Scan the bar code: SELECT GOOD READ LED DURATION SETTING.
5. Scan the appropriate three digits from the keypad in [Appendix D, Keypad](#) representing the duration which was determined in the steps above. You will hear a two-beep indication after the last character.



If you make a mistake before the last character, scan the CANCEL bar code to abort and not save the entry string. You can then start again at the beginning.

6. Scan the ENTER/EXIT PROGRAMMING MODE bar code to exit Programming Mode.

This completes the procedure. See [Table 39](#) for some examples of how to set this feature.

Table 39. Good Read LED Duration Setting Examples

STEP	ACTION	EXAMPLES			
1	Desired Setting	Good Read LED stays on until next trigger pull (00)	20ms	150ms	2550ms (2.55 sec.)
2	Divide by 10 (and pad with leading zeroes)	000	002	015	255
3	Scan ENTER/EXIT PROGRAMMING MODE				
4	Scan SELECT GOOD READ LED DURATION SETTING				
5	Scan Three Characters From Appendix D, Keypad	'0', '0' and '0'	'0', '0' and '2'	'0', '1' and '5'	'2', '5' and '5'
6	Scan ENTER/EXIT PROGRAMMING MODE				

Scanning Features

Scan Mode

This mode is associated with typical handheld reader operation. Selects the scan operating mode for the reader. The following selections are valid for all models:

Trigger Single: When the trigger is pulled, scanning is activated until one of the following occurs:

- **Scanning Active Time** has elapsed
- a label has been read
- the trigger is released

Trigger Hold Multiple: When the trigger is pulled, scanning starts and the product scans until the trigger is released or **Scanning Active Time** has elapsed. Reading a label does not disable scanning. **Double Read Timeout** prevents undesired multiple reads of the same label while in this mode.

Trigger Pulse Multiple: When the trigger is pulled, continuous scanning is activated until **Scanning Active Time** has elapsed or the trigger has been released and pulled again. **Double Read Timeout** prevents undesired multiple reads of the same label while in this mode.

Flashing: The reader flashes on and off regardless of the trigger status. Flash rate is controlled by **Flash On Time** and **Flash Off Time**. When Flash is ON the imager reads continuously; when Flash is OFF scanning is deactivated.

Always On: No trigger pull is required to read a bar code. Scanning is continually on. If the trigger is pulled, the reader acts as if it is in Trigger Single Mode. **Double Read Timeout** prevents undesired multiple reads of the same label while in this mode.

Stand Mode: No trigger pull is required to read a bar code. Scanning is turned on automatically when an item is placed in the reader's field of view. **Double Read Timeout** prevents undesired multiple reads while in this mode.

Stand Mode Off Time

This feature specifies the amount of time reader illumination stays off after pulling the trigger when in Stand Mode. The configurable range is 01 to 32 by 01 in increments of 500ms (500ms to 16 seconds).

Follow these instructions to set this feature:

1. Determine the desired setting.
2. Pad the result with leading zeroes to yield two digits. For example: 2 = 02, 5 = 05, 20 = 20, etc.
3. Go to [page 73](#) and scan the ENTER/EXIT PROGRAMMING MODE bar code to enter Programming Mode.
4. Scan the bar code: Set Stand Mode Illuminator Off Time.
5. Scan the appropriate two digits from the keypad in [Appendix D, Keypad](#), that represent the setting which was determined in the steps above. You will hear a two-beep indication after the last character.
6. Scan the ENTER/EXIT PROGRAMMING MODE bar code to exit Programming Mode.

This completes the procedure. See [Table 40](#) for some examples of how to set this feature.

Table 40. Stand Mode Off Time

STEP	ACTION	EXAMPLES			
1	Desired Setting	500 ms	1 Second	5.5 Seconds	16 Seconds
2	Pad leading zero	01	02	11	32
3	Scan ENTER/EXIT PROGRAMMING MODE				
4	Scan SELECT STAND MODE OFF TIME				
5	Scan Two Characters From Appendix D, Keypad	'0' and '1'	'0' and '2'	'1' and '1'	'3' and '2'
6	Scan ENTER/EXIT PROGRAMMING MODE				

Scanning Active Time

This setting specifies the amount of time that the reader stays in scan ON state once the state is entered. The range for this setting is from 1 to 255 seconds in 1-second increments.

Follow these instructions to set this feature:

1. Determine the desired setting.
2. Pad the result with leading zeroes to yield three digits. For example: 0 = 000, 5 = 005, 20 = 020, etc.
3. Go to [page 74](#) and scan the ENTER/EXIT PROGRAMMING MODE bar code to enter Programming Mode.
4. Scan the bar code: SELECT SCANNING ACTIVE TIME SETTING.
5. Scan the appropriate three digits from the keypad in [Appendix D, Keypad](#), that represent the duration which was determined in the steps above. You will hear a two-beep indication after the last character.



If you make a mistake before the last character, scan the CANCEL bar code to abort and not save the entry string. You can then start again at the beginning.

6. Scan the ENTER/EXIT PROGRAMMING MODE bar code to exit Programming Mode.

This completes the procedure. See [Table 41](#) for some examples of how to set this feature.

Table 41. Scanning Active Time Setting Examples

STEP	ACTION	EXAMPLES			
1	Desired Setting	1 Second	90 Sec. (1.5 min.)	180 Sec. (3 min.)	255 Seconds (4.25 min.)
2	Pad leading zero(es)	001	090	180	255
3	Scan ENTER/EXIT PROGRAMMING MODE				
4	Scan SELECT SCANNING ACTIVE TIME SETTING				
5	Scan Three Characters From Appendix D, Keypad	'0', '0' and '1'	'0', '9' and '0'	'1', '8' and '0'	'2', '5' and '5'
6	Scan ENTER/EXIT PROGRAMMING MODE				

Aiming Duration Time

Specifies the frame of time the aiming pointer remains on after decoding a label, when in trigger single mode. The range for this setting is from 1 to 255 seconds in 1-second increments.

Follow these instructions to set this feature:

1. Determine the desired setting.
2. Pad the result with leading zeroes to yield three digits. For example: 0 = 000, 5 = 005, 20 = 020, etc.
3. Go to [page 76](#) and scan the ENTER/EXIT PROGRAMMING MODE bar code to enter Programming Mode.
4. Scan the bar code: SELECT AIMING DURATION TIME SETTING.
5. Scan the appropriate three digits from the keypad in [Appendix D, Keypad](#), that represent the duration which was determined in the steps above. You will hear a two-beep indication after the last character.



If you make a mistake before the last character, scan the CANCEL bar code to abort and not save the entry string. You can then start again at the beginning.

6. Scan the ENTER/EXIT PROGRAMMING MODE bar code to exit Programming Mode.

This completes the procedure. See [Table 42](#) for some examples of how to set this feature.

Table 42. Aiming Duration Time Setting Examples

STEP	ACTION	EXAMPLES			
1	Desired Setting	1 Second	90 Sec. (1.5 min.)	180 Sec. (3 min.)	255 Seconds (4.25 min.)
2	Pad leading zero(es)	001	090	180	255
3	Scan ENTER/EXIT PROGRAMMING MODE				
4	Scan SELECT AIMING DURATION TIME SETTING				
5	Scan Three Characters From Appendix D, Keypad	'0', '0' and '1'	'0', '9' and '0'	'1', '8' and '0'	'2', '5' and '5'
6	Scan ENTER/EXIT PROGRAMMING MODE				

Flash On Time

This feature specifies the ON time for the indicator LED while in Flash Mode. The selectable range is 100 to 9,900 milliseconds (0.1 to 9.9 seconds), in 100 millisecond increments.

Follow these instructions to set this feature.

1. Determine the desired setting in milliseconds.
2. Divide the desired setting by 100 (setting is in 100ms increments). Pad the result with leading zeroes to yield two digits. For example: 0 = 00, 5 = 05, 20 = 20, etc.
3. Go to [page 74](#) and scan the ENTER/EXIT PROGRAMMING MODE bar code to enter Programming Mode.
4. Scan the bar code: SELECT FLASH ON TIME SETTING.
5. Scan the appropriate two digits from the keypad in [Appendix D, Keypad](#) representing the duration which was determined in the steps above. You will hear a two-beep indication after the last character.



If you make a mistake before the last character, scan the CANCEL bar code to abort and not save the entry string. You can then start again at the beginning.

6. Scan the ENTER/EXIT PROGRAMMING MODE bar code to exit Programming Mode.

This completes the procedure. See [Table 43](#) for examples of how to set this feature.

Table 43. Flash On Time Setting Examples

STEP	ACTION	EXAMPLES			
1	Desired Setting	500ms	1,000ms (1 sec.)	5200ms (5.2 sec.)	9,900ms (9.9 sec.)
2	Divide by 100 (and pad with leading zeroes to yield two digits)	05	10	52	99
3	Scan ENTER/EXIT PROGRAMMING MODE				
4	Scan SELECT FLASH ON TIME SETTING				
5	Scan Two Characters From Appendix D, Keypad	'0' and '5'	'1' and '0'	'5' and '2'	'9' and '9'
6	Scan ENTER/EXIT PROGRAMMING MODE				

Flash Off Time

This feature specifies the OFF time for the indicator LED while in Flash Mode. The selectable range is 100 to 9,900 milliseconds (0.1 to 9.9 seconds), in 100 millisecond increments.

Follow these instructions to set this feature.

1. Determine the desired setting in milliseconds.
2. Divide the desired setting by 100 (setting is in 100ms increments). Pad the result with leading zeroes to yield two digits. For example: 0 = 00, 5 = 05, 20 = 20, etc.
3. Go to [page 75](#) and scan the ENTER/EXIT PROGRAMMING MODE bar code to enter Programming Mode.
4. Scan the bar code: SELECT FLASH OFF TIME SETTING.
5. Scan the appropriate two digits from the keypad in [Appendix D, Keypad](#), that represent the duration which was determined in the steps above. You will hear a two-beep indication after the last character.



If you make a mistake before the last character, scan the CANCEL bar code to abort and not save the entry string. You can then start again at the beginning.

6. Scan the ENTER/EXIT PROGRAMMING MODE bar code to exit Programming Mode.

This completes the procedure. See [Table 44](#) for some examples of how to set this feature.

Table 44. Flash Off Time Setting Examples

STEP	ACTION	EXAMPLES			
1	Desired Setting	500ms	1,000ms (1 sec.)	5200ms (5.2 sec.)	9,900ms (9.9 sec.)
2	Divide by 100 (and pad with leading zeroes to yield two digits)	05	10	52	99
3	Scan ENTER/EXIT PROGRAMMING MODE				
4	Scan SELECT FLASH OFF TIME SETTING				
5	Scan Two Characters From Appendix D, Keypad	'0' and '5'	'1' and '0'	'5' and '2'	'9' and '9'
6	Scan ENTER/EXIT PROGRAMMING MODE				

Multiple Labels Ordering by Code Symbology

This feature Specifies the transmission ordering by symbology type, when Multiple Labels per Frame is enabled. Up to six symbologies can be selected. Zeroes must be added to pad the string to 12 characters if not using all six symbologies.

The labels are ordered first as specified in the output mask. Labels present in the volume but not specified will be transmitted as unspecified symbologies in random order as allowed by the reading time sequence. For each label decoded in the volume the reader signals the standard beeper and LED indications.

To specify the symbology order:

1. Determine the symbologies and order you want to specify.
2. Use [Table 46 on page 286](#) to find the hex values for up to six symbologies.
3. Go to [page 80](#) and scan the ENTER/EXIT PROGRAMMING MODE bar code to enter Programming Mode.
4. Scan the bar code: "SELECT SYMBOLOGIES FOR MULTIPLE LABELS ORDERING".
5. Scan the appropriate two alphanumeric characters from the keypad in [Appendix D, Keypad](#), that represent the desired character/value in step 2 above.
6. Scan zeroes if needed to make a 12-character string.
7. When finished, scan the ENTER/EXIT PROGRAMMING MODE bar code to exit Programming Mode.

This completes the procedure. See [Table 45](#) for some examples of how to set this feature.

Table 45. Multiple Labels Ordering by Code Symbology Examples

STEP	ACTION	EXAMPLES			
1	Desired symbology	Code 39	Data Matrix	Code 128	Aztec
2	Hex equivalent from ASCII Chart	24	0E	0C	4E
3	Scan ENTER/EXIT PROGRAMMING MODE				
4	Scan SELECT SYMBOLOGIES FOR MULTIPLE LABELS ORDERING				
5	Scan Two Characters From Appendix D, Keypad	'2' and '4'	'0' and 'E'	'0' and 'C'	'4' and 'E'
	RESULT	0x240E0C4E0000			
6	Scan ENTER/EXIT PROGRAMMING MODE				

[Table 46 on page 286](#) shows the hex value associated with each symbology.

Table 46. Symbology Hex Values

Hex Value	Symbology ID	Hex Value	Symbology ID
00	Don't care	2C	GTIN5
01	UPC-A	2D	GTIN8
02	UPC-E	2E	S2OF5
03	EAN8	2F	PDF417
04	EAN13	30	CODE11
05	UPC2	31	IATA
06	UPC5	32	MICRO_PDF
07	C128_ADDON	33	GS1 DataBar_LIM_ID
0A	EAN128	34	GS1 DataBar_LIM_COMP
0B	C128_PROGRAMMING_LABEL	35	GS1 DataBar_Omnidirectional_COMP
0C	CODE128	36	GS1 DataBar_EXP_COMP
0D	FNC3_C128_LABEL	37	GENERIC_DATA
0E	DATA MATRIX	38	CC_A
0F	MAXICODE	39	CC_B
10	QRCODE	3A	CC_C
11	Reserved	3B	LABELIMAGE
12	Reserved	3C	CAPTURE_IMAGE_LABEL
13	CODE49	3D	Reserved
14	UPC-E2	3E	M2OF5
15	UPC-E5	3F	D2OF5
16	Reserved	40	PLESSEY65
17	UPC-A2	42	ISSN
18	UPC-A5	43	ISBT
19	Reserved	44	Reserved
1A	EAN82	45	TIMER_EXPIRED_EVENT
1B	EAN85	46	FOLLETT_2OF5
1C	Reserved	47	Reserved
1D	EAN132	48	Reserved
1E	EAN135	49	CODE39_CIP
1F	EAN138	4A	ABC_CODABAR
20	ISBN_ID	4B	I2OF5_CIP
21	TWO_LABEL_PAIR	4C	C2OF5
22	I2OF5	4D	IND2OF5
23	CODABAR	4E	AZTEC
24	CODE39	4F	UPC-E_COMP
25	PHARMAC39	50	UPC-A_COMP
26	MSI_PLESSEY	51	EAN8_COMP
27	CODE93	52	EAN13_COMP
28	RSS_EXP_ID	53	EAN128_COMP
29	RSS_14_ID	54	DATA MATRIX_PROGRAMMING_LABEL
2A	GTIN	55	LABEL_ID_MAX
2B	GTIN2	FF	INVALID_LABEL_TYPE

Motion Features

Motionless Timeout

This setting specifies the amount of time that the reader takes to assume that it is in a motionless condition. The range for this setting is from 500 msec to 25.5 seconds, in 100 millisecond increments.

Follow these instructions to set this feature.

1. Determine the desired setting.
2. Pad the result with leading zeroes to yield three digits. For example: 0.5 = 005 = 00, 5 = 050, 20 = 200, etc.
3. Go to [page 206](#) and scan the ENTER/EXIT PROGRAMMING MODE bar code to enter Programming Mode.
4. Scan the bar code: SELECT MOTIONLESS TIMEOUT SETTING.
5. Scan the appropriate three digits from the keypad in [Appendix D, Keypad](#) representing the duration which was determined in the steps above. You will hear a two-beep indication after the last character.



If you make a mistake before the last character, scan the CANCEL bar code to abort and not save the entry string. You can then start again at the beginning.

6. Scan the ENTER/EXIT PROGRAMMING MODE bar code to exit Programming Mode.

This completes the procedure. See [Table 47](#) for examples of how to set this feature.

Table 47. Motionless Timeout Setting Examples

STEP	ACTION	EXAMPLES			
1	Desired Setting	500ms	1 sec.	10 sec	9,900ms (9.9 sec.)
2	Divide by 100 (and pad with leading zeroes to yield two digits)	005	010	100	250
3	Scan ENTER/EXIT PROGRAMMING MODE				
4	Scan SELECT MOTIONLESS TIMEOUT SETTING				
5	Scan Two Characters From Appendix D, Keypad	'0', '0' and '5'	'0', '1' and '0'	'1', '0', and '0'	'2', '5', and '0'
6	Scan ENTER/EXIT PROGRAMMING MODE				

Wireless Features

Automatic Configuration Update

When this feature is enabled, the base station and reader will keep their configurations synchronized. If a reader's configuration is altered by reading programming labels, this change is automatically transferred and updated in a linked base station. Likewise, if the base station's configuration is changed using Aladdin or by host commands, then the reader's configuration will automatically be updated if this feature is enabled.

RF Address Stamping

Source Radio Address Delimiter Character

This option specifies the delimiter character to be placed between the label data and radio address when address stamping is enabled.



This feature only applies if "Source Radio Address Transmission" on page 217 is enabled.

Follow these instructions to select the delimiter character:

1. Determine the desired character, then find its hexadecimal equivalent on the [ASCII Chart](#) on the inside back cover. A setting of 00 specifies no delimiter character.
2. Go to [page 218](#) and scan the ENTER/EXIT PROGRAMMING MODE bar code to enter Programming Mode.
3. Scan the bar code: SET SOURCE RADIO ADDRESS DELIMITER CHARACTER.
4. Scan the appropriate two digits from the keypad in [Appendix D, Keypad](#), that represent the hexadecimal characters which were determined in the steps above. You will hear a two-beep indication after the last character.



If you make a mistake before the last character, scan the CANCEL bar code to abort and not save the entry string. You can then start again at the beginning.

5. Scan the ENTER/EXIT PROGRAMMING MODE bar code to exit.

Table 48. Source Radio Address Delimiter Character Setting Examples

STEP	ACTION	EXAMPLES			
1	Desired Setting	No delimiter character	, (comma)	- (dash)	/ (slash)
2	Scan ENTER/EXIT PROGRAMMING MODE				
3	Scan SET SOURCE RADIO ADDRESS DELIMITER CHARACTER				
4	Scan Two Characters From Appendix D, Keypad	'0' and '0'	'2' and 'C'	'2' and 'D'	'2' AND 'F'
5	Scan ENTER/EXIT PROGRAMMING MODE				

STAR Radio Protocol Timeout

This parameter sets the valid wait time before transmission between the handheld reader and Base Station is considered failed.

When setting this parameter, take into consideration the radio traffic (number of readers in the same area). The selectable range for this feature is from 02 to 25 seconds.

Follow these instructions to set this feature:

1. Determine the desired setting.
2. Pad the number with leading zeroes to yield two digits. For example: 2 = 02, 5 = 05, 25 = 25, etc
3. Go to [page 235](#) and scan the ENTER/EXIT PROGRAMMING MODE barcode to enter Programming Mode.
4. Scan the barcode: SELECT RADIO PROTOCOL TIMEOUT.
5. Scan the appropriate two digits from the keypad in [Appendix D, Keypad](#), that represent the duration which was determined in the steps above. You will hear a two-beep indication after the last character.



If you make a mistake before the last character, scan the CANCEL barcode to abort and not save the entry string. You can then start again at the beginning.

6. Scan the ENTER/EXIT PROGRAMMING MODE barcode to exit Programming Mode.

This completes the procedure. See [Table 49](#) for some examples of how to set this feature.

Table 49. STAR Radio Protocol Timeout Examples

STEP	ACTION	EXAMPLES			
1	Desired Setting	2 Seconds	5 Seconds	10 Seconds	25 Seconds
2	Pad with leading zero(es)	02	05	10	25
3	Scan ENTER/EXIT PROGRAMMING MODE				
4	Scan SELECTSTAR RADIO PROTOCOL TIMEOUT SETTING				
5	Scan Two Characters From Appendix D, Keypad	'0' and '2'	'0' and '5'	'1' and '0'	'2' AND '5'
6	Scan ENTER/EXIT PROGRAMMING MODE				

PM9500-Only Features

Changing System Speed in Normal Mode

1. Link the PM9500 with a BC9xxx Base.
2. With the PM9500, read a Compatible Mode programming label on [page 238](#) to set low, intermediate, or high speed.
3. Place the PM9500 into the BC9xxx.

The Reader and Base will now be linked at the new programmed speed.

This feature can also be programmed using Datalogic Aladdin.

1. On the BC9xxx Base, change the Compatible mode parameter to low, intermediate, or high speed through Aladdin.
2. Place an unlinked PM9500 onto the BC9xxx base.

The Reader and base will link with the new programmed speed.

Bluetooth-Only Features

Bluetooth Pin Code

This option specifies the 4-character or 16-character pin code to be used for authentication of the Bluetooth link. To set the pin code:

1. Scan the ENTER/EXIT PROGRAMMING MODE bar code to enter Programming Mode, then enable "[Bluetooth Security Mode](#)" on [page 224](#).
2. Specify the desired pin code length (4 or 16) by scanning the appropriate bar code in "[Select PIN Code Length](#)" on [page 224](#).
3. Determine the desired characters. For example, D254 or STOR12345678135M.
4. Convert the characters to hexadecimal using the [ASCII Chart](#) on the inside back cover of this manual.
5. Go to [page 224](#) and Scan the bar code: SET 4 CHAR PIN CODE or SET 16-CHAR PIN CODE.
6. Scan the appropriate alphanumeric characters from the keypad in [Appendix D, Keypad](#), representing the hexadecimal entries determined in the steps above. You will hear a two-beep indication after the last character.



If you make a mistake before the last character, scan the CANCEL bar code to abort and not save the entry string. You can then start again at the beginning.

7. Scan the ENTER/EXIT PROGRAMMING MODE bar code to exit Programming Mode.



Changing the pin code setting will unlink the devices. If the Automatic Configuration Update is set to the default enabled setting, the devices must only be relinked. If the Automatic Configuration Update is set to the disabled setting, the Pin Code setting must also be updated in the Base Station using Aladdin. After the Base Station has been updated, the devices must be relinked.

Table 50. Bluetooth Pin Code Setting Examples

STEP	ACTION	EXAMPLES	
1	Desired Setting	D254	STOR12345678135M
2	Convert the characters to hexadecimal	44 32 35 34	53 54 4F 52 31 32 33 34 35 36 37 38 31 33 35 4D
3	Scan ENTER/EXIT PROGRAMMING MODE		
4	Scan SET Bluetooth PIN CODE		
5	Scan 8 or 32 Alphanumeric Characters From Appendix D, Keypad	44323534	53544F5231323334353637383133354D
6	Scan ENTER/EXIT PROGRAMMING MODE		

NOTES



Chapter 5

Message Formatting



Message Formatting is available for PM9500 models only.

For this feature to be operational, the scanner must be set to Ignore Host Commands (see [page 23](#)).

A message from the Host to the base must follow these rules:

- If Address stamping options or address delimiter are enabled on the base, the Host replay must have address field and delimiter too. Otherwise the message will be ignored. Address delimiter is present only when address stamping is enabled.
- Address stamping is necessary to correctly route the message to the PM9500, especially when more than one handheld is linked to the same base. Address stamping could be disabled if the system is in point to point configuration. If address stamping is not enabled, the messages are addressed to the first handheld linked to the base.
- The maximum character length for messages is 48.
- Messages end with "CR" 0x0D ASCII character. The CR character cannot be contained in the middle.
- Messages cannot start with '\$' or '#' because these are reserved for Service mode command
- Base station can receive host message only if Host Commands Obey/Ignore is set to Ignore.
- Message could be sent to the handheld in response to a Label when "Transmit mode" require Ack from Host (see transmit mode parameter) or at any time. When messages are sent not in response to a label must start with DC2 0x12 ASCII character and could be sent in any transmit mode setting.
- Message could be sent to all handhelds linked to the base by using a Multicast message:
`00 00 00 00 2A AA`
- In order to receive a message, handhelds must not be in sleep state.

The format of the ACK from Host message (used for transmission mode 02) is:

```
[Scanner_Addr] [Scanner_Addr_delimiter] MESSAGE <CR>
```

The format of a generic message From Host to HH is:

```
[Scanner_Addr] [Scanner_Addr_delimiter] DC2 MESSAGE <CR>
```

where DC2 is ASCII 0x12 (^R) character.

[Items in square brackets are optional.]

- If you want to control the Scanner's beeper from the host, you will also probably want to disable the good transmission beep that is emitted when the code is received from the cradle. (See "[Wireless Beeper Features](#)" on [page 209](#)).

The message field can store plain text and escape sequences.

- Escape sequences are interpreted as commands.

Cursor Control

ESC [n A	Up n rows, no scroll
ESC [n B	Down n rows, no scroll
ESC [n C	Right n columns
ESC [n D	Left n columns
ESC [G	CR
ESC [r ; c H	Move to row r , column c (ESC[1;1H is the upper left character position of the display)
ESC D	Down 1 row, with scroll
ESC E	CR and cursor down 1 row with scroll
ESC M	Up 1 row and scroll



- Since CR is used as the message terminator, you must use ESC [G or ESC E to print a CR.
- The cursor row position is not affected by the currently selected font. The display always has 4 rows, so when writing with the large font, actually two rows are written to: the current one and the one below it. You will need two ESC E commands to step from one row to the next when using the large font.
- The cursor column position is affected by the currently selected font. Therefore, column 6 is 36 pixels from the left border only if you last selected the 6x8 font; otherwise it could be 48 or 72 pixels from the left border.

Font Selection

ESC [0 m	Normal mode
ESC [7 m	Reverse mode
ESC # 4	Large font: subsequent characters are written on the current row and the row below it using the 12x16 font which allows for two rows of eight characters on the display.
ESC # 5	Normal font: subsequent characters are written using the 6x8 font, which allows for four rows of sixteen characters on the display.
ESC # 7	Medium font: subsequent characters are written using the 8x8 font, which allows for four rows of twelve characters on the display.

Clearing Display

ESC [0 K	From cursor position to end of line inclusive
ESC [1 K	From beginning of line to cursor position (not inclusive)
ESC [2 K	Entire line
ESC [0 J	From cursor position to end of display inclusive
ESC [1 J	From beginning of display to cursor position (not inclusive)
ESC [2 J	Entire display; moves cursor to upper left corner on display

LED and Beeper Control

ESC [0 q	Emit short High tone + short delay
ESC [1 q	Emit short Low tone + short delay
ESC [2 q	Emit long Low tone + short delay
ESC [3 q	Emit good read tone
ESC [4 q	Emit bad tx tone
ESC [5 q	Wait 100 ms
ESC [6 q	Turn on the green LED
ESC [7 q	Turn off the green LED
ESC [8 q	Turn on the red LED
ESC [9 q	Turn off the red LED

The LED control escape sequences are intended to activate the LEDs for short periods of time and can be used in combination with the Beeper. The LED and Beeper will be controlled by the system after the entire command sequence is interpreted.

Example:

ESC [6 q ESC [3 q ESC [7 q	Turns on the green LED, emits a good read tone, and turns off the green LED.
ESC [6 q ESC [5 q ESC [7 q	Turns on the green LED for 100 ms and then turns off the green LED.

Setting RTC

ESC [0 p d d m m y y	Set date to day, month, year
ESC [1 p h h m m	Set time to hours, minutes; seconds are automatically set to 00.

NOTES



Appendix A

Technical Specifications

The tables that follow contain Physical and Performance Characteristics, User Environment and Regulatory information. Table 52 provides Standard Cable Pinouts.

Table 51. Technical Specifications

Item	Description		
Physical Characteristics			
Dimensions	Height: 212 mm Length: 110 mm Width: 74 mm		
Weight (without cable)	330 gr (without cable)		
Electrical Characteristics			
PD9530 models			
Voltage & Current	PD9530/ PD9530-HP	PD9530-HPE	PD9530-DPM
Input Voltage	5 VDC +/- 5%	10 to 30 VDC	5 VDC +/- 5%
Input Current			
Operating (typical):	335mA	135mA @ 10V	350mA
Operating (max):	475mA	300mA @ 10V	480mA
Idle/Standby (typical)	180mA	60mA @ 10V	120mA
PBT9500 and PM9500 models			
Battery Type	Li-Ion battery pack		
Charge time for full charge from full discharge	4 hours with external power supply adapter ^a		
	Typical 10 hours with Host power (in this case no supply adapter is needed) ^a		
Operating autonomy (continuous reading)	30,000 reads (typical)		
Cradle consumption and DC input supply range	Volt 10-30 VDC; Power <8W ^b ; Max 500mA when in host/bus powered mode ^b .		

a. Charge Times are much lower when battery is within daily typical operating condition.

b. Typical input current measured under factory default configuration.

Performance Characteristics		
Light Source	LED	
Roll (Tilt) Tolerance	± 180°	
Pitch Tolerance	± 40°	
Skew (Yaw) Tolerance	± 40°	
Print Contrast Minimum	15% minimum reflectance	
	Standard Optics Model	High Performance (HP)
Resolution	Max resolution 1D 4 mils Max resolution 2D 7.5 mils	1D 2.5 mil 2D 4 mil

Depth of Field (Typical)^a		
Symbology	Standard Optics Model	High Performance (HP)
Code 39	4 mils: 6-17 cm 20 mils: 4-55 cm 40 mils: 4-85 cm	2.5 mils: 2-6 cm 20 mils: 3-70 cm 40 mils: 3-110 cm
EAN 13	13 mils: 4-48 cm 13	13 mils: 3-60 cm
PDF-417	10 mils: 2-25 cm	10 mils: 2-30 cm
DataMatrix	7.5 mils: 7-14 cm 10 mils: 4-18 cm	4mil: 2-6 cm 10mil: 2-20 cm
Minimum Element Width	Standard Range: 1D Minimum Resolution = 4 mil PDF-417 Minimum Resolution = 5 mil Data Matrix Minimum Resolution = 7 mil	High Density: 1D Minimum Resolution = 2.5 mil PDF-417 Minimum Resolution = 4 mil Data Matrix Minimum Resolution = 5 mil

^a13 mils DOF based on EAN. All other 1D codes are Code 39. All labels grade A, 300 lux ambient light, 20°C, label inclination 10°

Decode Capability	
Item	Description
1D Bar Codes	GS1 Databar linear codes, UPC/EAN (A,E,13,8), UPC/EAN with P2/P5 Addons, UPC/EAN Coupons, ISBN, Code128, EAN128, ISBT128, Code39, Code39 Full ASCII, Code39 CIP, Code 32, Codabar, Interleaved 2 of 5, IATA, Industrial 2 of 5, Standard 2 of 5, Code11, MSI, Plessey, Code 93, Follet 2/5
2D / Stacked Codes	DataMatrix, MaxiCode and QR Codes(QR, Micro QR and Multiple QR codes), Aztec - Postal codes including Australian Post, China Post, Japanese Post, KIX Post, Korea Post, Planet Code, Postnet, Royal Mail Code (RM45CC), IMB - stacked codes including EAN/JAN Composites; GS1 Databar Composites, GS1 Databar Expanded Stacked; GS1 DataBar Stacked; GS1 DataBar Stacked Omnidirectional; MacroPDF; Micro PDF417; PDF417; UPC A/E Composites, French CIP13, Grid Matrix (Chinese) code
High Performance Model: Same as above.	
Interfaces Supported^a	RS-232, Keyboard Wedge (IBM AT-PS/2), USB (USB-KBD, USB-COM).

a. See "Interface Selection" on page 14 for a listing of available interface sets by model type.

Item	Description
User Environment	
Operating Temperature	-4° to 122° F (-20° - +50° C)
Storage Temperature	-40° to 158° F (-40° to 70° C)
Humidity	0 to 95% non-condensing
Drop Specifications	Scanner withstands >50 times 6.5' (2 m) drops to concrete
Ambient Light Immunity	100,000 Lux
Contaminants Spray/Rain/Dust/Particulates	IP65
ESD Level	20 KV
Beeper/Speaker	>= 80 dB @ 10 cm

Item	Description		
Regulatory			
	PD9530 (Corded Models)	PBT9500	PM9500
Electrical Safety	UL 60950, CSA C22.2 No. 60950, IEC 60950	UL 60950, CSA C22.2 No. 60950, IEC 60950	UL 60950, CSA C22.2 No. 60950, IEC 60950
EMI/RFI	North America (FCC) : Part 15 Class B; Canada (IC) : ICES-003 Class B; Russia (Gost); European Union EMC Directive; VCCI-Japan; Korean KCC; Taiwan EMC (BSMI); Australia (ACMA); Mexico (NOM Nyce)	North America (FCC) : Canada (IC); Russia (Gost); European Union R&TTE Directive; Japan; Korean KCC; Taiwan; Australia; Mexico	433 MHz model Europe - CE, Russia – Gost; Australia – Ctick; China – SRRC; Singapore – IDA, Anatel Brazil 910 MHz model USA/Canada – FCC/ IC; Mexico – NOM + Cofetel
Laser Safety	IEC Class 2 Radiation 1 mW Avg., Emitted wavelength 650 nm, 12ms pulse, Beam Divergence 8.4 deg x 8.1 deg (' plus" pattern)	IEC Class 2 Radiation 1 mW Avg., Emitted wavelength 650 nm, 12ms pulse, Beam Divergence 8.4 deg x 8.1 deg (' plus" pattern)	IEC Class 2 Radiation 1 mW Avg., Emitted wavelength 650 nm, 12ms pulse, Beam Divergence 8.4 deg x 8.1 deg (' plus" pattern)
Complies with FDA performance standards for laser products except for deviations pursuant to Laser Notice No. 50, dated June 24, 2007.			

Radio Features	
PBT9500	
Frequency working center	2400 to 2483.5 MHz
Range (in open air)	up to 100m
Max number of devices per base station	7

PM9500		
Frequency working center	910MHz	433MHz
Programmable Speed	40 kb/s 100 kb/s 500 kb/s (default)	19.2 kb/s 100 kb/s 500 kb/s (default)
Typical Range (in open air)	100m	from 50m (at 500 kb/s) to 100m (at 19.2kb/s)
Max number of devices per base station	16	

Imager Labeling

Sample labels are shown for illustrative purposes only. Please view the labels on your product for actual details, as they may vary from those depicted.

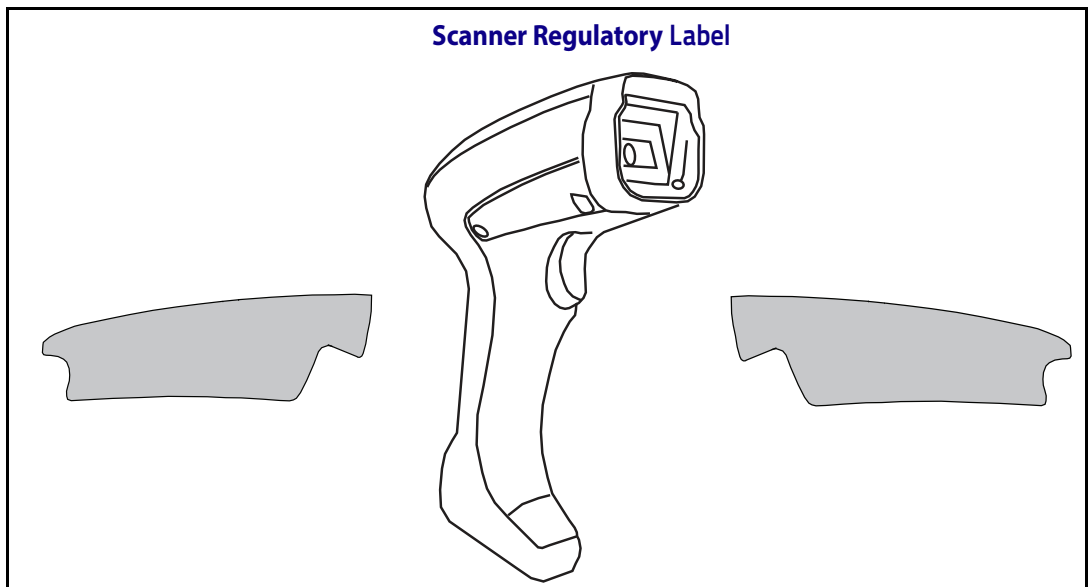

Standard Cable Pinouts

The data below provides standard pinout information for the interface cable.

Figure 11. Standard Cable Pinouts: Handheld

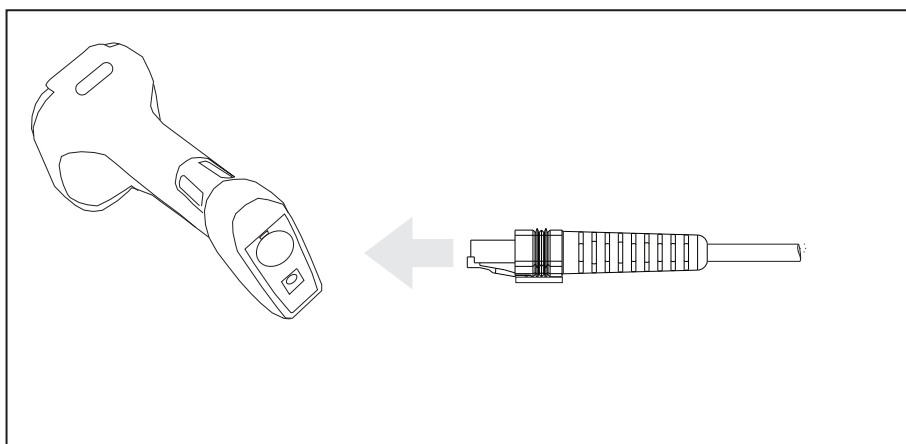

The signal descriptions in [Table 52](#) apply to the connector on the reader and are for reference only.

Table 52. Standard Cable Pinouts

Pin	RS-232	USB	Keyboard Wedge
1	RTS (out)		
2		D+	CLKIN (KBD side)
3		D-	DATAIN (KBD side)
4	GND	GND	GND
5	RX		
6	TX		
7	VCC	VCC	VCC
8			CLKOUT (PC side)
9			DATAOUT (PC side)
10	CTS (in)		

LED and Beeper Indications

The reader's beeper sounds and its LED illuminates to indicate various functions or errors on the reader. An optional "Green Spot" also performs useful functions. The tables below list these indications. One exception to the behaviors listed in the tables is that the reader's functions are programmable, and may or may not be turned on. For example, certain indications such as the power-up beep can be disabled using programming bar code labels.

Table 53. LED and Beeper Indications

INDICATION	DESCRIPTION	LED	BEEPER
Power-up Beep	The reader is in the process of powering-up.		Reader beeps four times at highest frequency and volume upon power-up.
Good Read Beep	A label has been successfully scanned by the reader.	LED behavior for this indication is configurable via the feature 'Good Read: When to Indicate'	The reader will beep once at current frequency, volume, tonal setting and duration upon a successful label scan.
Green Spot ^a flashes momentarily	Upon successful read of a label, the software turns the green spot on for the time specified by the configured value.	N/A	N/A
Image Capture	When ready to capture image	Blue light flashes 2 times when updating	N/A

a. Except when in sleep mode or when a **Good Read LED Duration** other than 00 is selected

Table 54. Programming Mode Indications

Programming Mode - The following indications ONLY occur when the reader is in Programming Mode.

INDICATION	DESCRIPTION	LED	BEEPER
Label Programming Mode Entry	A valid programming label has been scanned.	LED blinks continuously	Reader sounds four low frequency beeps.
Label Programming Mode Rejection of Label	A label has been rejected.	N/A	Reader sounds three times at lowest frequency & current volume.
Label Programming Mode Acceptance of Partial Label	In cases where multiple labels must be scanned to program one feature, this indication acknowledges each portion as it is successfully scanned.	N/A	Reader sounds one short beep at highest frequency & current volume.

Programming Mode Indications (continued)			
INDICATION	DESCRIPTION	LED	BEEPER
Label Programming Mode Acceptance of Programming	Configuration option(s) have been successfully programmed via labels and the reader has exited Programming Mode.	N/A	Reader sounds one high frequency beep and 4 low frequency beeps followed by reset beeps.
Label Programming Mode Cancel Item Entry	Cancel label has been scanned.	N/A	Reader sounds two times at low frequency and current volume.

Error Codes

Upon startup, if the reader sounds a long tone, this means the reader has not passed its automatic Selftest and has entered FRU (Field Replaceable Unit) isolation mode. If the reader is reset, the sequence will be repeated. Press and release the trigger to hear the FRU indication code.

The following table describes the LED flashes/beep codes associated with an error found.

NUMBER OF LED FLASHES/ BEEPS	Error	CORRECTIVE ACTION
1	Configuration	Contact Helpdesk for assistance
2	Interface PCB	
6	Digital PCB	
11	Imager	

Base Station Indications (Cordless Models ONLY)

Base Station Button Indicators

BUTTON PUSH EVENT	CORDLESS	RED INDICATOR(**)	GREEN INDICATOR(**)
Push at power-up	force device connection (Aladdin)	Off	Slow blink Fast blink
< 5 sec	Paging	Off	Fast blink
5 to 10 sec	Unlink (Only Bluetooth)	Off	Slow blink



Appendix B

Sample Bar Codes

The sample bar codes in this appendix are typical representations for their symbology types.

1D Bar Codes

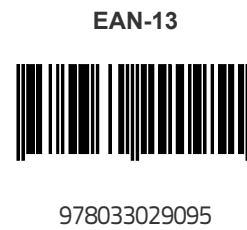

Sample Bar Codes (continued)

Code 32



B9P91Q

Codabar



13579

Code 93



ABCDEF

Code 11



123456789

GS1 DataBar™ (RSS)



GS1 DataBar™ variants must be enabled to read the bar codes below (see "GS1 DataBar™ Omnidirectional" on page 151).

GS1 DataBar™ Expanded Stacked



10293847560192837465019283746029478450366523

GS1 DataBar™ Expanded



1234890hjo9900mnb

GS1 DataBar™ Limited



08672345650916

GS1 DataBar™-14

GS1 DataBar™ Omnidirectional Truncated



55432198673467

GS1 DataBar™ Omnidirectional Stacked



90876523412674

GS1 DataBar™ Omnidirectional Stacked



78123465709811

2D Bar Codes

Aztec



Datamatrix



China Sensible Code



MaxiCode

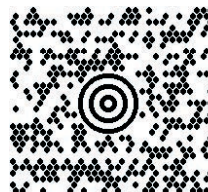

Test Message

PDF 417



ABCabc

Micro PDF 417



BV17453

QR Code

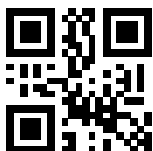

35900G9

Micro QR Code



123456

UCC Composite

(17) 050923 (10) ABC123



(01) 0 4012345 67890 1 1



Appendix C Standard Defaults

The most common configuration settings are listed in the “Default” column of the table below. Page references are also provided for feature descriptions and programming bar codes for each parameter. A column has also been provided for recording of your preferred default settings for these same configurable features.

Table 55. Standard Defaults

Parameter	Default	Your Setting	Page Number
GLOBAL INTERFACE FEATURES			
Host Commands — Obey/Ignore	Obey		23
USB Suspend Mode	Disable		23
RS-232 ONLY			
Baud Rate	115200		26
Data Bits	8 Data Bits		27
Stop Bits	1 Stop Bit		27
Parity	None		28
Handshaking Control	RTS		29
RS-232/USB-Com			
Intercharacter Delay	No Delay		31
Beep On ASCII BEL	Disable		31
Beep On Not on File	Enable		32
ACK NAK Options	Disable		32
ACK Character	'ACK'		33
NAK Character	'NAK'		33
ACK NAK Timeout Value	200 ms		34
ACK NAK Retry Count	3 Retries		34

Parameter	Default	Your Setting	Page Number
ACK NAK Error Handling	Ignore Errors Detected		35
Indicate Transmission Failure	Enable		35
Disable Character	'D'		36
Enable Character	'E'		36
KEYBOARD WEDGE			
Country Mode	U.S. Keyboard		38
Send Control Characters	00		41
Wedge Quiet Interval	100 ms		42
Intercode Delay	No Delay		42
Caps Lock State	Caps Lock OFF		43
Numlock	NumLock Key Unchanged		43
USB Keyboard Speed	1 ms		44
USB Keyboard Numeric Keypad	Standard Keys		45
USB-OEM			
USB-OEM Device Usage	Handheld		48
Interface Options	Ignore Scanner Configuration Host Commands		48
Data Format			
Global Prefix/Suffix (Header/Terminator)	No Global Prefix Global Suffix = 0x0D (CR)		50
Global AIM ID	Disable		51
Set AIM ID Individually for GS1-128	Enable		54
Label ID: Pre-Loaded Sets	EU Set		55
Individually Set Label ID	Disable		56
Case Conversion	Disable		61
Character Conversion	No Char Conversion		61
READING PARAMETERS			
Double Read Timeout	0.6 Second		63
Power On Alert	Power-up Beep		66
Good Read: When to Indicate	After Decode		66
Good Read Beep Type	Mono		67
Good Read Beep Frequency	High		67
Good Read Beep Length	80 ms		68

Parameter	Default	Your Setting	Page Number
Good Read Beep Volume	High		69
Good Read LED Duration	300 ms		70
Scanning Features			
Scan Mode	Trigger Single		71
Stand Mode Indication	Disable		72
Pick Mode	Disable		72
Stand Mode Sensitivity	Medium		73
Stand Mode Illumination Off Time	2 Seconds		73
Scanning Active Time	5 Seconds		74
Stand Illumination Control	OFF		74
Flash On Time	10 = Flash is ON for 1 Second		75
Flash Off Time	06 = Flash is OFF for 600ms		75
Aiming Pointer	Enable		76
Aiming Duration Timer	Aiming Off After Decoding		76
Green Spot Duration	300 ms		77
Partial Label Reading Control	Enable		77
Decode Negative Image	Disable		78
Multiple Label Reading			
Multiple Labels per Frame	Disable		79
Multiple Labels Ordering by Code Symbology	Random Order		80
Multiple Labels Ordering by Code Length	Disable		80
CODE SELECTION - 1D SYMBOLOGIES			
Code EAN/UPC			
Coupon Control	Enable only UPCA coupon decoding		83
UPC-A			
UPC-A Enable/Disable	Enable		84
UPC-A Check Character Transmission	Send		84
Expand UPC-A to EAN-13	Don't Expand		85
UPC-A Number System Character Transmission	Transmit		85

Parameter	Default	Your Setting	Page Number
UPC-A 2D Component	2D Component Not Required		86
UPC-E			
UPC-E Enable/Disable	Enable		86
UPC-E Check Character Transmission	Send		87
UPC-E 2D Component	2D Component Not Required		87
Expand UPC-E to EAN-13	Don't Expand		88
Expand UPC-E to UPC-A	Don't Expand		88
UPC-E Number System Character Transmission	Transmit		89
GTIN			
GTIN Formatting	Disable		89
EAN 13 (Jan 13)			
EAN 13 Enable/Disable	Enable		90
EAN 13 Check Character Transmission	Send		90
EAN-13 Flag 1 Character	Transmit		91
EAN-13 ISBN Conversion	Disable		91
EAN-13 2D Component	2D Component Not Required		92
ISSN			
ISSN Enable/Disable	Disable		92
EAN 8			
EAN 8 Enable/Disable	Enable		93
EAN 8 Check Character Transmission	Send		93
Expand EAN 8 to EAN 13	Disable		94
EAN 8 2D Component	2D Component Not Required		94
UPC/EAN Global Settings			
UPC/EAN Price Weight Check	Disable		95
UPC/EAN Quiet Zones	Two Modules		96
Add-Ons			
Optional Add-ons	Disable P2, P5 and P8		97
Optional Add-On Timer	70 ms		98
Optional GS1-128 Add-On Timer	Disable		100

Parameter	Default	Your Setting	Page Number
Code 39			
Code 39 Enable/Disable	Enable		103
Code 39 Check Character Calculation	Calculate Std Check		103
Code 39 Check Character Transmission	Send		104
Code 39 Start/Stop Character Transmission	Don't Transmit		105
Code 39 Full ASCII	Disable		105
Code 39 Quiet Zones	Small Quiet Zones on two sides		106
Code 39 Length Control	Variable		106
Code 39 Set Length 1	2		107
Code 39 Set Length 2	50		108
Trioptic Code			
Trioptic Code Enable/Disable	Disable		109
Code 32 (Italian Pharmaceutical Code)			
Code 32 Enable/Disable	Disable		109
Code 32 Check Character Transmission	Don't Send		110
Code 32 Start/Stop Character Transmission	Don't Transmit		110
Code 39 CIP (French Pharmaceutical Code)			
Code 39 CIP Enable/Disable	Disable		111
Special Codes			
Code 39 Danish PPT Enable/Disable	Disable		111
Code 39 LaPoste Enable/Disable	Disable		112
Code 39 PZN Enable/Disable	Disable		112
Code 128			
Code 128 Enable/Disable	Enable		113
Expand Code 128 to Code 39	Don't Expand		113
Code 128 Check Character Transmission	Don't Send		114
Code 128 Function Character Transmission	Don't Send		114
Code 128 Sub-Code Exchange Transmission	Disable		115
Code 128 Quiet Zones	Small Quiet Zones on two sides		115

Standard Defaults

Parameter	Default	Your Setting	Page Number
Code 128 Length Control	Variable		116
Code 128 Set Length 1	1		117
Code 128 Set Length 2	80		118
GS1-128			
GS1-128 Enable	Transmit in Code 128 Data Format		119
GS1-128 2D Component	Disable		119
ISBT 128			
ISBT 128 Concatenation	Disable		120
ISBT 128 Force Concatenation	Disable		120
ISBT 128 Concatenation Mode	Static		121
ISBT 128 Dynamic Concatenation Timeout	200 msec		122
Interleaved 2 of 5			
I 2 of 5 Enable/Disable	Disable		123
I 2 of 5 Check Character Calculation	Disable		124
I 2 of 5 Check Character Transmission	Send		125
I 2 of 5 Length Control	Variable		125
I 2 of 5 Set Length 1	6		126
I 2 of 5 Set Length 2	50		127
Interleaved 2 of 5 CIP HR			
Interleaved 2 of 5 CIP HR Enable/Disable	Disable		128
Follett 2 of 5			
Follett 2 of 5 Enable/Disable	Disable		128
Standard 2 of 5			
Standard 2 of 5 Enable/Disable	Disable		129
Standard 2 of 5 Check Character Calculation	Disable		129
Standard 2 of 5 Check Character Transmission	Send		130
Standard 2 of 5 Length Control	Variable		130
Standard 2 of 5 Set Length 1	8		131
Standard 2 of 5 Set Length 2	50		132
Industrial 2 of 5			
Industrial 2 of 5 Enable/Disable	Disable		133

Parameter	Default	Your Setting	Page Number
Industrial 2 of 5 Check Character Calculation	Disable		133
Industrial 2 of 5 Check Character Transmission	Enable		134
Industrial 2 of 5 Length Control	Variable		134
Industrial 2 of 5 Set Length 1	1		135
Industrial 2 of 5 Set Length 2	50		136
Code IATA			
IATA Enable/Disable	Disable		137
IATA Check Character Transmission	Enable		137
Codabar			
Codabar Enable/Disable	Disable		138
Codabar Check Character Calculation	Don't Calculate		138
Codabar Check Character Transmission	Send		139
Codabar Start/Stop Character Transmission	Transmit		139
Codabar Start/Stop Character Set	abcd/abcd		140
Codabar Start/Stop Character Match	Don't Require Match		140
Codabar Quiet Zones	Quiet Zones on two sides		141
Codabar Length Control	Variable		141
Codabar Set Length 1	3		142
Codabar Set Length 2	50		143
ABC Codabar	Disable		144
ABC Codabar			
ABC Codabar Enable/Disable	Disable		144
ABC Codabar Concatenation Mode	Static		144
ABC Codabar Dynamic Concatenation Timeout	200 msec		145
ABC Codabar Force Concatenation	Disable		146
Code 11			
Code 11 Enable/Disable	Disable		147
Code 11 Check Character Calculation	Check C and K		147
Code 11 Check Character Transmission	Send		148
Code 11 Length Control	Variable		148

Parameter	Default	Your Setting	Page Number
Code 11 Set Length 1	4		149
Code 11 Set Length 2	50		150
GS1 DataBar™ Omnidirectional			
GS1 DataBar™ Omnidirectional Enable/Disable	Disable		151
GS1 DataBar™ Omnidirectional GS1-128 Emulation	Disable		151
GS1 DataBar™ Omnidirectional 2D Component	2D component not required		152
GS1 DataBar™ Expanded			
GS1 DataBar™ Expanded Enable/Disable	Disable		152
GS1 DataBar™ Expanded GS1-128 Emulation	Disable		153
GS1 DataBar™ Expanded 2D Component	2D component not required		153
GS1 DataBar™ Expanded Length Control	Variable		154
GS1 DataBar™ Expanded Set Length 1	1		155
GS1 DataBar™ Expanded Set Length 2	74		156
GS1 DataBar™ Limited			
GS1 DataBar™ Limited Enable/Disable	Disable		157
GS1 DataBar™ Limited GS1-128 Emulation	Disable		157
GS1 DataBar™ Limited 2D Component	2D component not required		158
Code 93			
Code 93 Enable/Disable	Disable		158
Code 93 Check Character Calculation	Enable Check C and K		159
Code 93 Check Character Transmission	Enable		159
Code 93 Length Control	Variable		160
Code 93 Set Length 1	1		161
Code 93 Set Length 2	50		162
Code 93 Quiet Zones	Small Quiet Zones on two sides		163
MSI			
MSI Enable/Disable	Disable		163
MSI Check Character Calculation	Enable Mod10		164

Parameter	Default	Your Setting	Page Number
MSI Check Character Transmission	Enable		164
MSI Length Control	Variable		166
MSI Set Length 1	1		166
MSI Set Length 2	50		167
Plessey			
Plessey Enable/Disable	Disable		168
Plessey Check Character Calculation	Enable Plessey std. check char. verification		168
Plessey Check Character Transmission	Enable		169
Plessey Length Control	Variable		169
Plessey Set Length 1	1		170
Plessey Set Length 2	50		171
CODE SELECTION - 2D SYMBOLOGIES			
2D Maximum Decoding Time	350msec		174
2D Structured Append	Disable		175
2D Normal/Inverse Symbol Control	Both		175
Aztec Code Enable / Disable	Disable		176
Aztec Code Length Control	Enable		176
Aztec Code Length Control	Variable		176
Aztec Code Set Length 1	1		177
China Sensible Code Enable / Disable	Disable		179
China Sensible Code Length Control	Variable		179
China Sensible Code Set Length 1	1		180
China Sensible Code Set Length 2	7,827		181
Data Matrix Enable / Disable	Enable		182
Data Matrix Square/Rectangular Style	Both Square and Rectangular style		182
Data Matrix DPM Decoding Safety	1		183
Data Matrix Length Control	Variable		184
Data Matrix Set Length 1	1		184
Data Matrix Set Length 2	3,116		185
Maxicode Enable / Disable	Disable		186
Maxicode Primary Message Transmission	Disable		186
Maxicode Length Control	Variable		187

Parameter	Default	Your Setting	Page Number
Maxicode Set Length 1	1		187
Maxicode Set Length 2	0145		188
PDF417 Enable / Disable	Enable		189
PDF417 Length Control	Variable		189
PDF417 Set Length 1	1		190
PDF417 Set Length 2	2,710		191
Micro PDF417 Enable / Disable	Disable		192
Micro PDF417 Code 128 GS1-128 Emulation	Micro PDF AIM ID and label type		192
Micro PDF417 Length Control	Variable		193
Micro PDF417 Set Length 1	1		193
Micro PDF417 Set Length 2	0366		194
QR Code Enable / Disable	Enable		195
QR Code Length Control	Variable		195
QR Code Set Length 1	1		196
QR Code Set Length 2	7,089		197
Micro QR Code Enable/Disable	Disable		197
Micro QR Code Length Control	Variable		198
Micro QR Code Set Length 1	0001		198
Micro QR Code Set Length 2	0035		199
UCC Composite Enable / Disable	Disable		200
UCC Optional Composite Timer	Timer Disabled		201
Postal Code Selection	Disable all Postal codes		202
Postnet BB Control	Disable		203
Motion Features			
Motion Aiming Control	Enable		205
Motion Sensitivity	Medium		206
Motionless Timeout	2 seconds		206
Wireless Features			
Good Transmission Beep	Enable		209
Beep Frequency	Low		209
Beep Duration	80 msec		210
Beep Volume	High		211

Parameter	Default	Your Setting	Page Number
Disconnect Beep	Enable		211
Docking Beep	Enable		212
Leash Alarm	Disable		212
Automatic Configuration Update	Enable		214
Copy Configuration to Scanner	N/A		214
Copy Configuration to Base Station	N/A		214
Batch Mode	Disable		215
Send Batch	N/A		215
Erase Batch Memory	N/A		216
RF Batch Mode Transmit Delay	No Delay		216
Direct Radio Autolink	Unlink Label Required		217
Source Radio Address Transmission	Do not include		217
Source Radio Address Delimiter Character	No Delimiter Character		218
Current Date	YYMMDD		219
Current Time	HHMMSS		219
Date Tx Format	YYYY-MM-DD (ISO 8601)		220
Time Tx Format	hh:mm:ss (ISO 8601)		220
Date-Time Separator	Disable		221
Date-Time Transmission Order	Disable		222
Features for PBT9500 Models Only			
Bluetooth Security Mode	Disable		224
Bluetooth PIN Code	N/A		224
Select PIN Code Length	4-Character		224
Set PIN Code	1234		225
Bluetooth Poll Rate	20 ms		226
Power Off	N/A		227
Powerdown Timeout	30 minutes		227
Bluetooth HID Variable PIN Code	Static		228
Bluetooth HID Alt Mode	Off		229
Bluetooth HID Send Unknown ASCII Char	Disable		229
Bluetooth Max Client	2		230
Bluetooth Friendly Name	[SERIAL_NUMBER_SCANNER]		231

Parameter	Default	Your Setting	Page Number
Bluetooth Reconnect Attempt Mode	Enable		231
HID Country Mode	US		232
Features for PM9500 Models Only			
STAR Radio Protocol Timeout	02		235
STAR Radio Transmit Mode	Ack from cradle		236
Compatibility with PM8500			
Compatible Mode System Speed	High Speed		238
Base Address Stamping	Do Not Include		240
Base Address Delimiter Character	No Delimiter Character		240
RS-485 Master Header/Terminator (Prefix/Suffix)	N/A		241
RS-485 Cradle Address	N/A		241
RS-485 Slave Minimum Address	N/A		242
RS-485 Slave Maximum Address	N/A		242
RS-485 Network Working Mode	Disable		243
RS-485 Network Warning Message	Not Transmitted		244
RS-485 Transmission Warning Message	Not Transmitted		244
RS-485 Network Baud Rate	9600		244
Display and Keyboard Features			
Display Operating Mode	Local echo mode		245
Display Off Timeout	8 second delay		246
Backlight Enable	Disable		246
Display Contrast			247
Font Size	Small		247
Enable/disable buttons	All 4 keys enabled		248
Configure Actions for F1	No Actions Configured		250
Configure Actions for F2	No Actions Configured		250
Define Strings	N/A		251
Set String ID	N/A		252
Set String Header	No Header		252
Set String Terminator	No Terminator		253

Restore Factory Configuration

If you want to restore the Factory Configuration for your imager, scan either the Restore USA Factory Configuration bar code or the Restore EU Factory Configuration bar code below. Both labels restore the scanner configuration to the factory settings, including the interface type.



CAUTION

Scanning either of the "Restore Factory Configuration" commands below will result in the loss of any custom configuration settings for your device. Go to "Restore Custom Defaults" on page 18 if you want to restore your custom configuration settings.

The USA label restores Label IDs to those historically used in the USA. The EU label restores Label IDs to those historically used in Europe. The Label ID sets for USA and EU are shown in [Label ID: Pre-loaded Sets](#), starting on page 272 of this manual.



Restore USA Factory Configuration

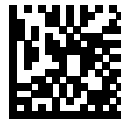

Restore EU Factory Configuration

NOTES



Appendix D Keypad

Use the bar codes in this appendix to enter numbers as you would select digits/characters from a keypad.



0



1

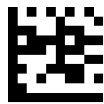

2



3

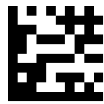

4



5



6



7

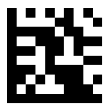

8

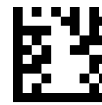

9

Keypad (continued)



A



B

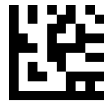

C



D



E



F



Appendix E

Scancode Tables

Control Character Emulation

Control character emulation selects from different scancode tables as listed in this appendix. Each of the control character sets below are detailed by interface type in the tables. These apply to Wedge and USB Keyboard platforms.

Control Character 00: Characters from 00 to 0x1F are sent as control character Ctrl+Keys, special keys are located from 0x80 to 0xA1.

Control Character 01: Characters from 00 to 0x1F are sent as control character Ctrl+Capital Key, special keys are located from 0x80 to 0xA1.

Control Character 02: Special keys are located from 00 to 0x1F and characters from 0x80 to 0xFE are intended as an extended ASCII table (Microsoft Windows Codepage 1252 — see [page 332](#)).

Single Press and Release Keys

In the following tables, Ar↓ means Alt right pressed and Ar↑ means Alt right released and so on. Definitions for other keys are Al (Alt left), Cr (Control Right), Cl (Control Left), Sh (shift). This method can be used for combining Alt, Control or Shift with other keys.

Example: Consider a Control character set to 00. If AltRight+A is required before sending a label to the host, it could be done by setting three Prefix keys in this way: 0x99 0x41 0x9A.

Interface Type PC AT PS/2, USB-Keyboard or USB-Keyboard for APPLE

Table 56. Scancode Set When Control Character is 00 or 01

	x0	x1	x2	x3	x4	x5	x6	x7	x8	x9	xA	xB	xC	xD	xE	xF
0x	NULL C+@	SOH C(S)+A	STX C(S)+B	ETX C(S)+C	EOT C(S)+D	ENQ C(S)+E	ACK C(S)+F	BEL C(S)+G	BS HT TAB	LF C(S)+J	VT C(S)+K	FF C(S)+L	CR Enter	SO C(S)+N	SI C(S)+O	
1x	DLE C(S)+P	DC1 C(S)+Q	DC2 C(S)+R	DC3 C(S)+S	DC4 C(S)+T	NAK C(S)+U	SYN C(S)+V	ETB C(S)+W	CAN C(S)+X	EM C(S)+Y	SUB C(S)+Z	ESC Esc	FS C+\ C+]	GS C+^	RS C+^	US C(S)+_
2x	SP	!	"	#	\$	%	&	'	()	*	+	,	-	.	/
3x	0	1	2	3	4	5	6	7	8	9	:	;	<	=	>	?
4x	@	A	B	C	D	E	F	G	H	I	J	K	L	M	N	O
5x	P	Q	R	S	T	U	V	W	X	Y	Z	[\]	^	_
6x	`	a	b	c	d	e	f	g	h	i	j	k	l	m	n	o
7x	p	q	r	s	t	u	v	w	x	y	z	{		}	~	Del
8x	€	Sh↓	Sh↑	Ins	Ent (keyp)	F1	F2	F3	F4	F5	F6	F7	F8	F9	F10	F11
9x	F12	Home	End	Pg Up	Pg Dwn	↑	↓	←	→	Ar↓	Ar↑	Al↓	Al↑	Cl↓	Cl↑	Cr↓
Ax	Cr↑		‘	f	„	...	†	‡	^	%	Š	<	Š	<	Œ	
Bx	°	±	²	³	´	µ	¶	·	,	ı	°	»	¼	½	¾	¿
Cx	À	Á	Â	Ã	Ä	Å	Æ	Ç	È	É	Ê	Ë	Ì	Í	Î	Ï
Dx	Ð		Ò	Ó	Ô	Õ	Ö	×	Ø	Ù	Ú	Û	Ü	Ý	Þ	ß
Ex	à	á	â	ã	ä	å	æ	ç	è	é	ê	ë	ì	í	î	ï
Fx	ð	ñ	ò	ó	ô	õ	ö	÷	ø	ù	ú	û	ü	ý	þ	ÿ

Extended characters (sky blue) are sent through dedicated keys (when available in the selected country mode) or by using an Alt Mode sequence.

Interface Type PC AT PS/2, USB-Keyboard or USB-Keyboard for APPLE (continued)

Table 57. Scancode Set When Control Character is 02

	x0	x1	x2	x3	x4	x5	X6	x7	x8	x9	xA	xB	xC	xD	xE	xF
0x	Ar↓	Ar↑	Al↓	Al↑	Cl↓	Cl↑	Cr↓	Cr↑	BS	Tab	→	S+ Tab	Enter Keyprd	Enter	Ins	Pg Up
1x	Pg Dwn	Home	←	↓	↑	F6	F1	F2	F3	F4	F5	ESC	F7	F8	F9	F10
2x	Space	!	“	#	\$	%	&	‘	()	*	+	,	-	.	/
3x	0	1	2	3	4	5	6	7	8	9	:	;	<	=	>	?
4x	@	A	B	C	D	E	F	G	H	I	J	K	L	M	N	O
5x	P	Q	R	S	T	U	V	W	X	Y	Z	[\]	^	_
6x	`	a	b	c	d	e	f	g	h	i	j	k	l	m	n	o
7x	p	q	r	s	t	u	v	w	x	y	z	{		}	~	Del
8x	€		‘	f	„	…	†	‡	^	%	Š	<	Š	<	Œ	
9x		‘	’	“	”	•	–	—	~	™	š	>	œ		ž	ÿ
Ax	NBSP	ı	ç	£	¤	¥	¦	§	¨	©	ª	«	¬	-	®	¯
Bx	°	±	²	³	´	µ	¶	·	,	ı	°	»	¼	½	¾	¿
Cx	À	Á	Â	Ã	Ä	Å	Æ	Ç	È	É	Ê	Ë	Ì	Í	Î	Ï
Dx	Ð		Ò	Ó	Ô	Õ	Ö	×	Ø	Ù	Ú	Û	Ü	Ý	Þ	ß
Ex	à	á	â	ã	ä	å	æ	ç	è	é	ê	ë	ì	í	î	ï
Fx	ð	ñ	ò	ó	ô	õ	ö	÷	ø	ù	ú	û	ü	ý	þ	ÿ

Interface Type PC AT PS/2 Alt Mode or USB-Keyboard Alt Mode

Table 58. Scancode Set When Control Character is 00 or 01

	x0	x1	x2	x3	x4	x5	X6	x7	x8	x9	xA	xB	xC	xD	xE	Xf
0x	Alt+000	Alt+001	Alt+002	Alt+003	Alt+004	Alt+005	Alt+006	Alt+007	BS	HT TAB	Alt+010	Alt+011	Alt+012	CR Enter	Alt+014	Alt+015
1x	Alt+016	Alt+017	Alt+018	Alt+019	Alt+020	Alt+021	Alt+022	Alt+023	Alt+024	Alt+025	Alt+026	ESC Esc	Alt+028	Alt+029	Alt+030	Alt+031
2x	A+032	A+033	A+034	A+035	A+036	A+037	A+038	A+039	A+040	A+041	A+042	A+043	A+044	A+045	A+046	A+047
3x	A+048	A+049	A+050	A+051	A+052	A+053	A+054	A+055	A+056	A+057	A+058	A+059	A+060	A+061	A+062	A+063
4x	A+064	A+065	A+066	A+067	A+068	A+069	A+070	A+071	A+072	A+073	A+074	A+075	A+076	A+077	A+078	A+079
5x	A+080	A+081	A+082	A+083	A+084	A+085	A+086	A+087	A+088	A+089	A+090	A+091	A+092	A+093	A+094	A+095
6x	A+096	A+097	A+098	A+099	A+100	A+101	A+102	A+103	A+104	A+105	A+106	A+107	A+108	A+109	A+110	A+111
7x	A+112	A+113	A+114	A+115	A+116	A+117	A+118	A+119	A+120	A+121	A+122	A+123	A+124	A+125	A+126	A+127
8x	€	Sh↓	Sh↑	Ins	Ent (keyp)	F1	F2	F3	F4	F5	F6	F7	F8	F9	F10	F11
9x	F12	Home	End	Pg Up	Pg Dwn	↑	↓	←	→	Ar↓	Ar↑	Al↓	Al↑	Cl↓	Cl↑	Cr↓
Ax	Cr↑	A+0161	A+0162	A+0163	A+0164	A+0165	A+0166	A+0167	A+0168	A+0169	A+0170	A+0171	A+0172	A+0173	A+0174	A+0175
Bx	A+0176	A+0177	A+0178	A+0179	A+0180	A+0181	A+0182	A+0183	A+0184	A+0185	A+0186	A+0187	A+0188	A+0189	A+0190	A+0191
Cx	A+0192	A+0193	A+0194	A+0195	A+0196	A+0197	A+0198	A+0199	A+0200	A+0201	A+0202	A+0203	A+0204	A+0205	A+0206	A+0207
Dx	A+0208	A+0209	A+0210	A+0211	A+0212	A+0213	A+0214	A+0215	A+0216	A+0217	A+0218	A+0219	A+0220	A+0221	A+0222	A+0223
Ex	A+0224	A+0225	A+0226	A+0227	A+0228	A+0229	A+0230	A+0231	A+0232	A+0233	A+0234	A+0235	A+0236	A+0237	A+0238	A+0239
Fx	A+0240	A+0241	A+0242	A+0243	A+0244	A+0245	A+0246	A+0247	A+0248	A+0249	A+0250	A+0251	A+052	A+0253	A+0254	A+0255

Interface Type PC AT PS/2 Alt Mode or USB-Keyboard Alt Mode (continued)

Table 59. Scancode Set When Control Character is 02

	x0	x1	x2	x3	x4	x5	X6	x7	x8	x9	xA	xB	xC	xD	xE	xF
0x	Ar↓	Ar↑	Al↓	Al↑	Cl↓	Cl↑	Cr↓	Cr↑	BS	Tab	→	S+ Tab	Enter Keypd	Enter	Ins	Pg Up
1x	Pg Dwn	Home	←	↓	↑	F6	F1	F2	F3	F4	F5	ESC	F7	F8	F9	F10
2x	A+032	A+033	A+034	A+035	A+036	A+037	A+038	A+039	A+040	A+041	A+042	A+043	A+044	A+045	A+046	A+047
3x	A+048	A+049	A+050	A+051	A+052	A+053	A+054	A+055	A+056	A+057	A+058	A+059	A+060	A+061	A+062	A+063
4x	A+064	A+065	A+066	A+067	A+068	A+069	A+070	A+071	A+072	A+073	A+074	A+075	A+076	A+077	A+078	A+079
5x	A+080	A+081	A+082	A+083	A+084	A+085	A+086	A+087	A+088	A+089	A+090	A+091	A+092	A+093	A+094	A+095
6x	A+096	A+097	A+098	A+099	A+100	A+101	A+102	A+103	A+104	A+105	A+106	A+107	A+108	A+109	A+110	A+111
7x	A+112	A+113	A+114	A+115	A+116	A+117	A+118	A+119	A+120	A+121	A+122	A+123	A+124	A+125	A+126	A+127
8x	A+0128	A+0129	A+0130	A+0131	A+0132	A+0133	A+0134	A+0135	A+0136	A+0137	A+0138	A+0139	A+0140	A+0141	A+0142	A+0143
9x	A+0144	A+0145	A+0146	A+0147	A+0148	A+0149	A+0150	A+0151	A+0152	A+0153	A+0154	A+0155	A+0156	A+0157	A+0158	A+0159
Ax	A+0160	A+0161	A+0162	A+0163	A+0164	A+0165	A+0166	A+0167	A+0168	A+0169	A+0170	A+0171	A+0172	A+0173	A+0174	A+0175
Bx	A+0176	A+0177	A+0178	A+0179	A+0180	A+0181	A+0182	A+0183	A+0184	A+0185	A+0186	A+0187	A+0188	A+0189	A+0190	A+0191
Cx	A+0192	A+0193	A+0194	A+0195	A+0196	A+0197	A+0198	A+0199	A+0200	A+0201	A+0202	A+0203	A+0204	A+0205	A+0206	A+0207
Dx	A+0208	A+0209	A+0210	A+0211	A+0212	A+0213	A+0214	A+0215	A+0216	A+0217	A+0218	A+0219	A+0220	A+0221	A+0222	A+0223
Ex	A+0224	A+0225	A+0226	A+0227	A+0228	A+0229	A+0230	A+0231	A+0232	A+0233	A+0234	A+0235	A+0236	A+0237	A+0238	A+0239
Fx	A+0240	A+0241	A+0242	A+0243	A+0244	A+0245	A+0246	A+0247	A+0248	A+0249	A+0250	A+0251	A+052	A+0253	A+0254	A+0255

Digital Interface

Table 60. Scancode Set When Control Character is 00 or 01

	X0	x1	x2	x3	x4	x5	x6	x7	x8	x9	xA	xB	xC	xD	xE	xF
0x	NULL C+@	SOH C(S)+A	STX C(S)+B	ETX C(S)+C	EOT C+D	ENQ C(S)+E	ACK C(S)+F	BEL C(S)+G	BS	HT TAB	LF C(S)+J	VT C(S)+K	FF C(S)+L	CR Enter	SO C(S)+N	SI C(S)+O
1x	DLE C(S)+P	DC1 C(S)+Q	DC2 C(S)+R	DC3 C(S)+S	DC4 C(S)+T	NAK C(S)+U	SYN C(S)+V	ETB C(S)+W	CAN C(S)+X	EM C(S)+Y	SUB C(S)+Z	ESC Esc	FS C(S)+\	GS C+]	RS C(S)+^	US C(S)+_
2x	Space	!	“	#	\$	%	&	‘	()	*	+	,	-	.	/
3x	0	1	2	3	4	5	6	7	8	9	:	;	<	=	>	?
4x	@	A	B	C	D	E	F	G	H	I	J	K	L	M	N	O
5x	P	Q	R	S	T	U	V	W	X	Y	Z	[\]	^	_
6x	`	a	b	c	d	e	f	g	h	i	j	k	l	m	n	o
7x	p	q	r	s	t	u	v	w	x	y	z	{		}	~	Del
8x		Sh↓	Sh↑	Ins	Ent (keyp)	F1	F2	F3	F4	F5	F6	F7	F8	F9	F10	F11
9x	F12	F13	F14	F15	F16	↑	↓	←	→					Cl↓	Cl↑	

Table 61. Scancode Set When Control Character is 02

	X0	x1	x2	x3	x4	x5	x6	x7	x8	x9	xA	xB	xC	xD	xE	xF
0x					Cl↓	Cl↑			BS	Tab	à	S+ Tab	Enter Keypd	Enter	Ins	
1x			←	↓	↑	F6	F1	F2	F3	F4	F5	ESC	F7	F8	F9	F10
2x	Space	!	“	#	\$	%	&	‘	()	*	+	,	-	.	/
3x	0	1	2	3	4	5	6	7	8	9	:	;	<	=	>	?
4x	@	A	B	C	D	E	F	G	H	I	J	K	L	M	N	O
5x	P	Q	R	S	T	U	V	W	X	Y	Z	[\]	^	_
6x	`	a	b	c	d	e	f	g	h	i	j	k	l	m	n	o
7x	p	q	r	s	t	u	v	w	x	y	z	{		}	~	Del

IBM31xx 102-key

Table 62. Scancode Set When Control Character is 00 or 01

	X0	x1	x2	x3	x4	x5	x6	x7	x8	x9	xA	xB	xC	xD	xE	xF
0x	NULL C+@	SOH C(S)+A	STX C(S)+B	ETX C(S)+C	EOT C+D	ENQ C(S)+E	ACK C(S)+F	BEL C(S)+G	BS	HT TAB	LF C(S)+J	VT C(S)+K	FF C(S)+L	CR Enter	SO C(S)+N	SI C(S)+O
1x	DLE C(S)+P	DC1 C(S)+Q	DC2 C(S)+R	DC3 C(S)+S	DC4 C(S)+T	NAK C(S)+U	SYN C(S)+V	ETB C(S)+W	CAN C(S)+X	EM C(S)+Y	SUB C(S)+Z	ESC Esc	FS C(S)+\	GS C+]	RS C(S)+^	US C(S)+_
2x	Space	!	“	#	\$	%	&	‘	()	*	+	,	-	.	/
3x	0	1	2	3	4	5	6	7	8	9	:	;	<	=	>	?
4x	@	A	B	C	D	E	F	G	H	I	J	K	L	M	N	O
5x	P	Q	R	S	T	U	V	W	X	Y	Z	[\]	^	_
6x	‘	a	B	c	d	e	f	g	h	i	j	k	l	m	n	o
7x	p	q	R	s	t	u	v	w	x	y	z	{		}		Del
8x		Sh↓	Sh↑	Ins	Ent (keyp)	F1	F2	F3	F4	F5	F6	F7	F8	F9	F10	F11
9x	F12	Enter	Reset	Insert	Delete	Field -	Field +	Enter paddle	Printl	Ar↓	Ar↑	Al↓	Al↑	Cl↓	Cl↑	Cr↓
Ax	Cr↑															

Table 63. Scancode Set When Control Character is 02

	X0	x1	x2	x3	x4	x5	x6	x7	x8	x9	xA	xB	xC	xD	xE	xF
0x	Ar↓	Ar↑	Al↓	Al↑	Cl↓	Cl↑	Cr↓	Cr↑	BS	Tab	→	S+ Tab	Enter Keyprd	Enter	Ins	Pg Up
1x	Pg Dwn	Home	←	↓	↑	F6	F1	F2	F3	F4	F5	ESC	F7	F8	F9	F10
2x	Space	!	“	#	\$	%	&	‘	()	*	+	,	-	.	/
3x	0	1	2	3	4	5	6	7	8	9	:	;	<	=	>	?
4x	@	A	B	C	D	E	F	G	H	I	J	K	L	M	N	O
5x	P	Q	R	S	T	U	V	W	X	Y	Z	[\]	^	_
6x	‘	a	B	c	d	e	f	g	h	i	j	k	l	m	n	o
7x	p	q	R	s	t	u	v	w	x	y	z	{		}		Del

IBM XT

Table 64. Scancode Set When Control Character is 00 or 01

	X0	x1	x2	x3	x4	x5	x6	x7	x8	x9	xA	xB	xC	xD	xE	xF
0x	NULL C+@	SOH C(S)+A	STX C(S)+B	ETX C(S)+C	EOT C+D	ENQ C(S)+E	ACK C(S)+F	BEL C(S)+G	BS C(S)+H	HT TAB	LF C(S)+J	VT C(S)+K	FF C(S)+L	CR Enter	SO C(S)+N	SI C(S)+O
1x	DLE C(S)+P	DC1 C(S)+Q	DC2 C(S)+R	DC3 C(S)+S	DC4 C(S)+T	NAK C(S)+U	SYN C(S)+V	ETB C(S)+W	CAN C(S)+X	EM C(S)+Y	SUB C(S)+Z	ESC Esc	FS C(S)+\	GS C+]	RS C(S)+^	US C(S)+_
2x	Space	!	“	#	\$	%	&	‘	()	*	+	,	-	.	/
3x	0	1	2	3	4	5	6	7	8	9	:	;	<	=	>	?
4x	@	A	B	C	D	E	F	G	H	I	J	K	L	M	N	O
5x	P	Q	R	S	T	U	V	W	X	Y	Z	[\]	^	_
6x	‘	a	B	c	d	e	f	g	h	i	j	k	l	m	n	o
7x	p	q	R	s	t	u	v	w	x	y	z	{		}		Del
8x		Sh↓	Sh↑	Ins	Ent (keyp)	F1	F2	F3	F4	F5	F6	F7	F8	F9	F10	F11
9x	F12	Home	End	Pg Up	Pg Dwn	↑	↓	←	→	Ar↓	Ar↑	Al↓	Al↑	Cl↓	Cl↑	Cr↓
Ax	Cr↑															

Table 65. Scancode Set when Control Character 02

	X0	x1	x2	x3	x4	x5	x6	x7	x8	x9	xA	xB	xC	xD	xE	xF
0x	Ar↓	Ar↑	Al↓	Al↑	Cl↓	Cl↑	Cr↓	Cr↑	BS	Tab	→	S+ Tab	Enter Keyprd	Enter	Ins	Pg Up
1x	Pg Dwn	Home	←	↓	↑	F6	F1	F2	F3	F4	F5	ESC	F7	F8	F9	F10
2x	Space	!	“	#	\$	%	&	‘	()	*	+	,	-	.	/
3x	0	1	2	3	4	5	6	7	8	9	:	;	<	=	>	?
4x	@	A	B	C	D	E	F	G	H	I	J	K	L	M	N	O
5x	P	Q	R	S	T	U	V	W	X	Y	Z	[\]	^	_
6x	‘	a	B	c	d	e	f	g	h	i	j	k	l	m	n	o
7x	p	q	R	s	t	u	v	w	x	y	z	{		}		Del

Microsoft Windows Codepage 1252

Windows-1252 is a character encoding of the Latin alphabet, used by default in the legacy components of Microsoft Windows in English and some other Western languages.

	00	01	02	03	04	05	06	07	08	09	0A	0B	0C	0D	0E	0F	
00	NUL 0000	STX 0001	SOT 0002	ETX 0003	EOI 0004	ACK 0005	BEL 0006	BS 0007	HT 0008	LF 000A	VT 000B	FF 000C	CR 000D	SO 000E	SI 000F		
10	DLE 0010	DC1 0011	DC2 0012	DC3 0013	DC4 0014	NAK 0015	SYN 0016	ETB 0017	CAN 0018	EM 0019	SUB 001A	ESC 001B	PS 001C	GS 001D	RS 001E	US 001F	
20	SP 0020	! 0021	" 0022	# 0023	\$ 0024	% 0025	& 0026	' 0027	(0028) 0029	* 002A	+ 002B	, 002C	- 002D	. 002E	/ 002F	
30	0 0030	1 0031	2 0032	3 0033	4 0034	5 0035	6 0036	7 0037	8 0038	9 0039	: 003A	; 003B	< 003C	= 003D	> 003E	? 003F	
40	@ 0040	A 0041	B 0042	C 0043	D 0044	E 0045	F 0046	G 0047	H 0048	I 0049	J 004A	K 004B	L 004C	M 004D	N 004E	O 004F	
50	P 0050	Q 0051	R 0052	S 0053	T 0054	U 0055	V 0056	W 0057	X 0058	Y 0059	Z 005A	[005B	\ 005C] 005D	^ 005E	_ 005F	
60	` 0060	a 0061	b 0062	c 0063	d 0064	e 0065	f 0066	g 0067	h 0068	i 0069	j 006A	k 006B	l 006C	m 006D	n 006E	o 006F	
70	p 0070	q 0071	r 0072	s 0073	t 0074	u 0075	v 0076	w 0077	x 0078	y 0079	z 007A	{ 007B	 007C	} 007D	~ 007E	DEL 007F	
80	€ 20AC	• 20A2	ƒ 20A9	£ 20A3	„ 201E	… 2026	† 2020	‡ 2021	ˆ 02C5	‰ 2030	Š 0160	< 2038	€ 0162	• 017D	ž 017D	• 017D	• 017D
90	• 20B8	ˆ 20B8	ˆ 20B9	ˆ 20C	• 20D	• 2022	• 20B3	• 20B4	ˆ 02DC	• 2122	Š 0161	> 203A	€ 0163	• 017E	ž 017E	Ÿ 0178	
A0	NEST 00A0	ı 00A1	ı 00A2	£ 00A3	• 00A4	¥ 00A5	ı 00A6	• 00A7	• 00A8	© 00A9	• 00AA	« 00AB	¬ 00AC	• 00AD	• 00AE	• 00AF	
B0	• 00B0	± 00B1	z 00B2	• 00B3	ı 00B4	ı 00B5	ı 00B6	ı 00B7	ı 00B8	ı 00B9	ı 00BA	ı 00BB	ı 00BC	ı 00BD	ı 00BE	ı 00BF	
C0	À 00C0	Á 00C1	Â 00C2	Ã 00C3	Ä 00C4	Å 00C5	Æ 00C6	Ç 00C7	È 00C8	É 00C9	Ê 00CA	Ë 00CB	Ì 00CC	Í 00CD	Î 00CE	Ï 00CF	
D0	Ð 00D0	Ñ 00D1	Ò 00D2	Ó 00D3	Ô 00D4	Õ 00D5	Ö 00D6	× 00D7	Ø 00D8	Ù 00D9	Ú 00DA	Û 00DB	Ü 00DC	Ý 00DD	Þ 00DE	ß 00DF	
E0	à 00E0	á 00E1	â 00E2	ã 00E3	ä 00E4	å 00E5	æ 00E6	ç 00E7	è 00E8	é 00E9	ê 00EA	ë 00EB	ì 00EC	í 00ED	î 00EE	ï 00EF	
F0	ø 00F0	ñ 00F1	ò 00F2	ó 00F3	ô 00F4	õ 00F5	ö 00F6	÷ 00F7	ø 00F8	ù 00F9	ú 00FA	û 00FB	ü 00FC	ý 00FD	þ 00FE	ÿ 00FF	

NOTES

ASCII Chart

ASCII Char.	Hex No.	ASCII Char.	Hex No.	ASCII Char.	Hex No.	ASCII Char.	Hex No.
NUL	00	SP	20	@	40	'	60
SOH	01	!	21	A	41	a	61
STX	02	,	22	B	42	b	62
ETX	03	#	23	C	43	c	63
EOT	04	\$	24	D	44	d	64
ENQ	05	%	25	E	45	e	65
ACK	06	&	26	F	46	f	66
BEL	07	'	27	G	47	g	67
BS	08	(28	H	48	h	68
HT	09)	29	I	49	i	69
LF	0A	*	2A	J	4A	j	6A
VT	0B	+	2B	K	4B	k	6B
FF	0C	,	2C	L	4C	l	6C
CR	0D	-	2D	M	4D	m	6D
SO	0E	.	2E	N	4E	n	6E
SI	0F	/	2F	O	4F	o	6F
DLE	10	0	30	P	50	p	70
DC1	11	1	31	Q	51	q	71
DC2	12	2	32	R	52	r	72
DC3	13	3	33	S	53	s	73
DC4	14	4	34	T	54	t	74
NAK	15	5	35	U	55	u	75
SYN	16	6	36	V	56	v	76
ETB	17	7	37	W	57	w	77
CAN	18	8	38	X	58	x	78
EM	19	9	39	Y	59	y	79
SUB	1A	:	3A	Z	5A	z	7A
ESC	1B	;	3B	[5B	{	7B
FS	1C	<	3C	\	5C		7C
GS	1D	=	3D]	5D	}	7D
RS	1E	>	3E	^	5E	~	7E
US	1F	?	3F	_	5F	DEL	7F



www.datalogic.com

©2013 Datalogic, Inc. All rights reserved. Datalogic and the Datalogic logo are registered trademarks of Datalogic S.p.A. in many countries, including the U.S.A. and the E.U.

Datalogic ADC, Inc.

959 Terry Street | Eugene | OR 97402 | USA
Telephone: (1) 541-683-5700 | Fax: (1) 541-345-7140

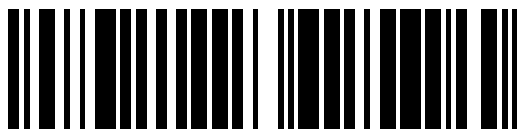

820053614 (Rev C) November 2013